

•General Description



The SJ MOSFET LH65R170 has the low $R_{DS(on)}$, low gate charge, fast switching and excellent avalanche characteristics. This device offers extremely fast and robust body diode, and is suitable for telecom and power supplies.

•Features

- Much lower $R_{on} \cdot A$ performance for On-state efficiency
- Much lower FOM for fast switching efficiency

•Application

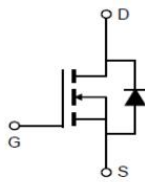
- LED/LCD/PDP TV and monitor Lighting
- Solar/Renewable/UPS-Micro Inverter System
- Power Supplies

	$V_{DS} = 650V$ $R_{DS(ON)} = 170m\Omega$ $I_D = 20A$
 TO-220F	 TO-220
■ RoHS COMPLIANT	

•Ordering Information:

Part number	LH65R170	LH65R170
Package	TO-220F	TO-220
Basic ordering unit (pcs)	1000	1000
Normal Package Material Ordering Code	LH65R170F-TO220F-TU	LH65R170T-TO220-TU
Halogen Free Ordering Code	LH65R170F-TO220F-TU-HF	LH65R170T-TO220-TU-HF

•Absolute Maximum Ratings (TC =25°C)

PARAMETER	SYMBOL	Value	UNIT
Drain-Source Breakdown Voltage	V_{DSS}	650	V
Gate-Source Voltage	V_{GS}	± 30	V
Continuous Drain Current	I_D	TC = 25°C	20
		TC = 100°C	12
Pulsed drain current (TC = 25°C, tp limited by Tjmax) ¹	I_D pulse	60	A
Single Pulse Avalanche Energy ¹	E_{AR}	3.5	A
Single Pulse Avalanche Energy ²	E_{AS}	484	mJ
Repetitive Avalanche Energy ¹	E_{AR}	0.7	mJ
Power Dissipation(TC=25°C)	P_D	TO-220:151	TO-220F:34
Operating Temperature and Storage Temperature Range	T_J/T_{STG}	$-55 \sim +150$	°C
MOSFET dv/dt ruggedness, $V_{DS}=0 \dots 480V$	dv/dt	50	V/ns
Reverse diode dv/dt, $V_{DS}=0 \dots 480V, I_{SD} \leq I_D$	dv/dt	15	V/ns

●Electronic Characteristics

PARAMETER	SYMBOL	TEST CONDITION	MIN	TYP	MAX	UNIT
Drain-Source Breakdown Voltage	BV_{DSS}	$V_{GS} = 0V, I_D = 250\mu A$	650	--	--	V
Gate Threshold Voltage	$V_{GS(TH)}$	$V_{DS} = V_{GS}, I_D = 250\mu A$	2.5	--	4.5	V
Drain-source On Resistance ³	$R_{DS(ON)}$	$V_{GS} = 10V, I_D = 7.5A$	--	0.15	0.17	Ω
Drain-Source Leakage Current	I_{DSS}	$V_{DS} = 650V, V_{GS} = 0V, T_J = 25^\circ C$	--	--	1	μA
		$V_{DS} = 650V, V_{GS} = 0V, T_J = 125^\circ C$	--	--	100	
Gate-Source Leakage Current	I_{GSS}	$V_{GS} = \pm 30$	--	--	± 100	nA
Forward Transconductance ³	R_G	f=1.0MHz open drain	--	--	12	Ω
Input Capacitance	C_{iss}	$V_{GS} = 0V,$ $V_{DD} = 520V$ f = 1.0MHz	--	1724	--	pF
Output Capacitance	C_{oss}		--	61	--	
Reverse transfer Capacitance	C_{rss}		--	6	--	
Turn-on delay time	$T_d(on)$	$I_D = 20A,$ $V_{DD} = 400V$ $R_G = 25\Omega$	--	15	--	nS
Rise time	T_r		--	59	--	
Turn -Off Delay Time	$T_d(off)$		--	121	--	
Fall time	T_f		--	44	--	
Total Gate Charge	Q_g	$I_D = 20A,$ $V_{DS} = 520V$ $V_{GS} = 10V$	--	38.5	--	nC
Gate-to-Source Charge	Q_{gs}		--	8	--	
Gate-to-Drain Charge	Q_{gd}		--	15	--	
Continuous Diode Forward Current	I_S		--	--	20	A
Pulsed Diode Forward Current	I_{SM}		--	--	60	A
Diode Forward Voltage	V_{SD}	$T_J = 25^\circ C, I_S = 20A$ $V_{GS} = 0V$	--	0.9	1.2	V
Reverse Recovery Time	t_{rr}	$V_{RR} = 400V,$ $I_f = I_S$ $di_F/dt = 100A/\mu s$	--	423	--	ns
Reverse Recovery Charge	Q_{rr}		--	5.3	--	μC
Peak Reverse Recovery Current	I_{RRM}		--	25	--	A

●Thermal Characteristics

PARAMETER	SYMBOL	MAX		UNIT
		TO-220F	TO-220	
Thermal Resistance Junction-case	R_{thJC}	3.7	0.83	$^\circ C/W$
Thermal Resistance Junction-ambient	R_{thJA}	80	62	$^\circ C/W$

Notes:

- 1.Repetitive Rating: Pulse width limited by maximum junction temperature.
2. $I_{AS} = 1.8A, V_{DD} = 50V, R_G = 25\Omega, \text{Starting } T_J = 25^\circ C$
3. Pulse Test : Pulse width $\leq 300\mu s, \text{Duty cycle } \leq 2\%$

● Typical Characteristics $T_J=25^\circ\text{C}$, unless otherwise noted

Figure 1. Output Characteristics

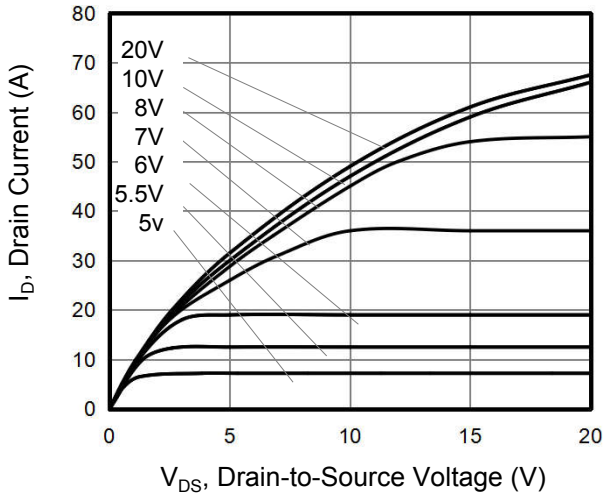

Figure 2. Transfer Characteristics

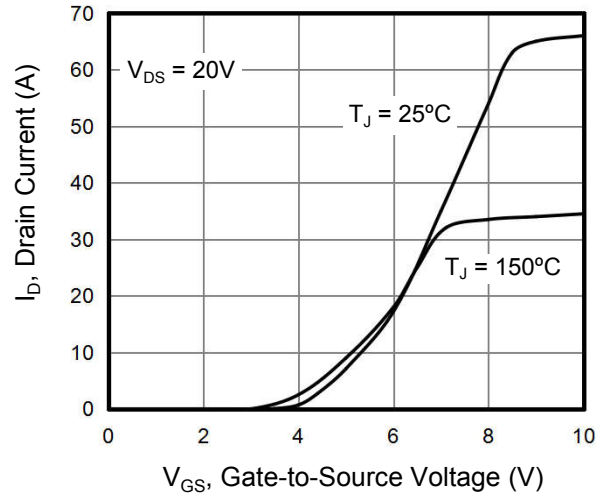

Figure 3. On-Resistance vs. Drain Current

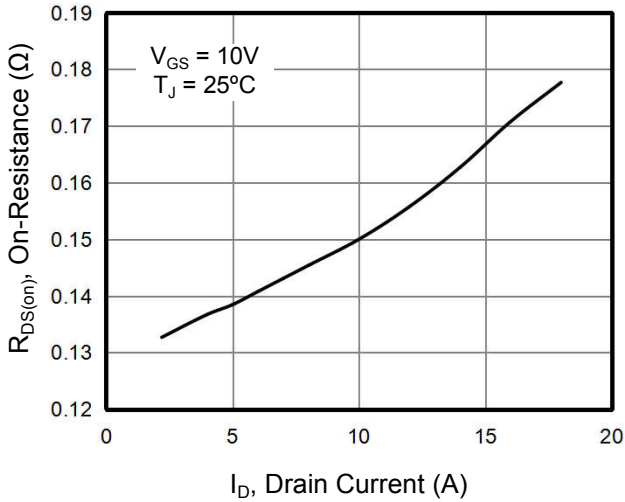

Figure 4. Capacitance

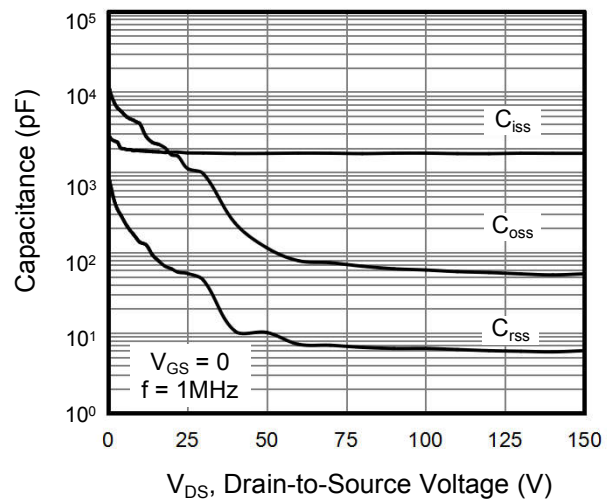

Figure 5. Gate Charge

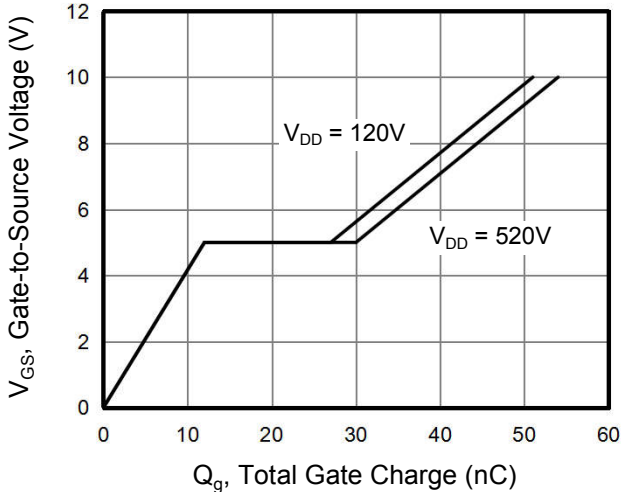
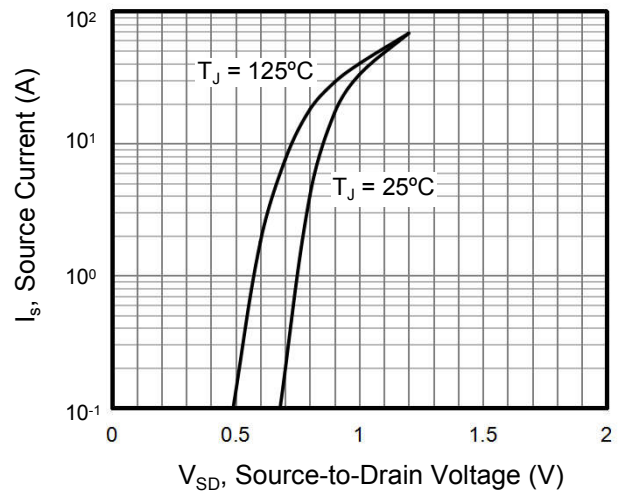

Figure 6. Body Diode Forward Voltage



• Typical Characteristics (Cont.)

Figure 7. On-Resistance vs. Junction Temperature

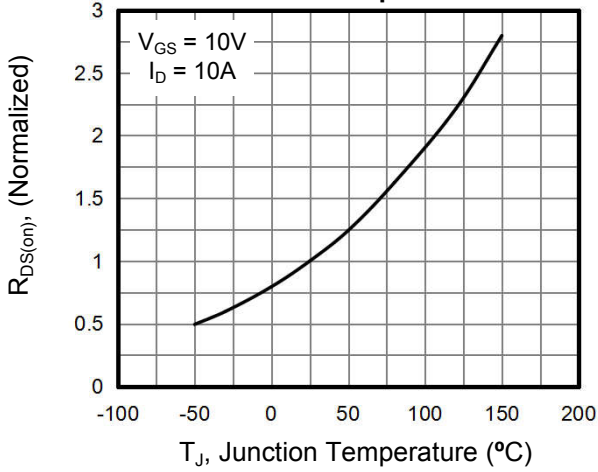

Figure 9. Transient Thermal Impedance

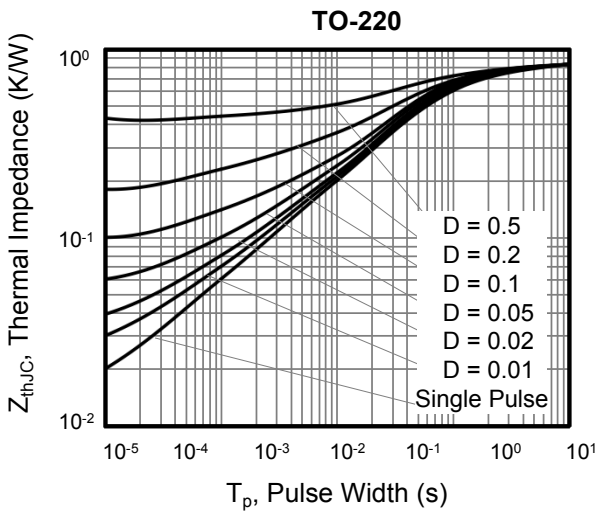

Figure 12. Safe operation area for TO-220

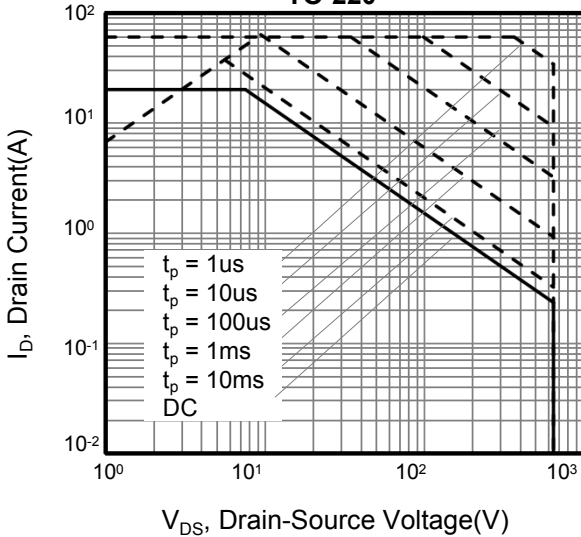

Figure 8. Threshold Voltage vs. Junction Temperature

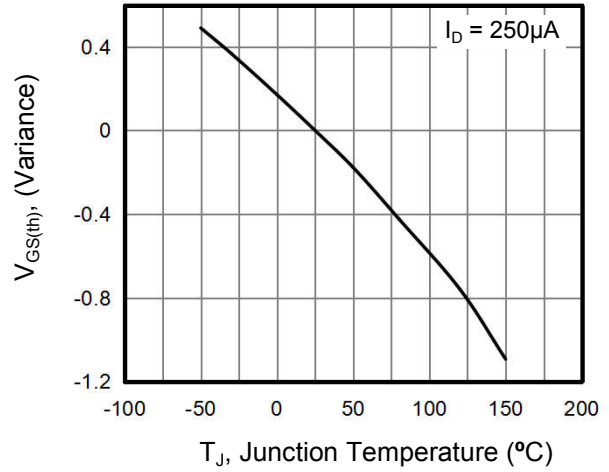

Figure 10. Transient Thermal Impedance TO-220F

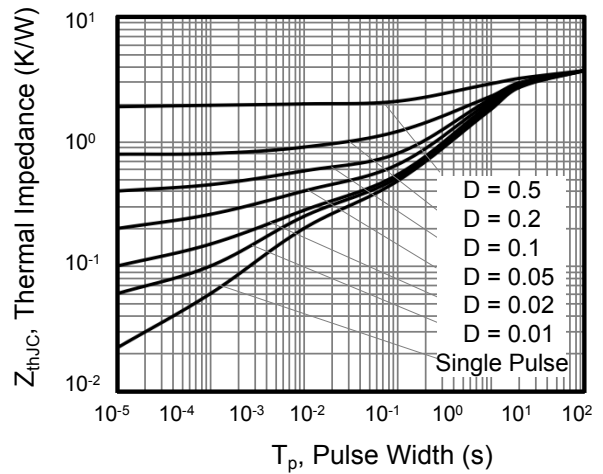
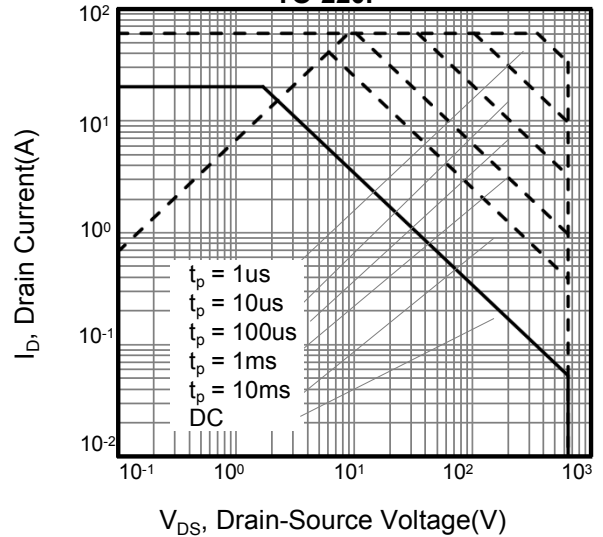

Figure 13. Safe operation area for TO-220F



● Test Circuit and Waveform

Figure A: Gate Charge Test Circuit and Waveform

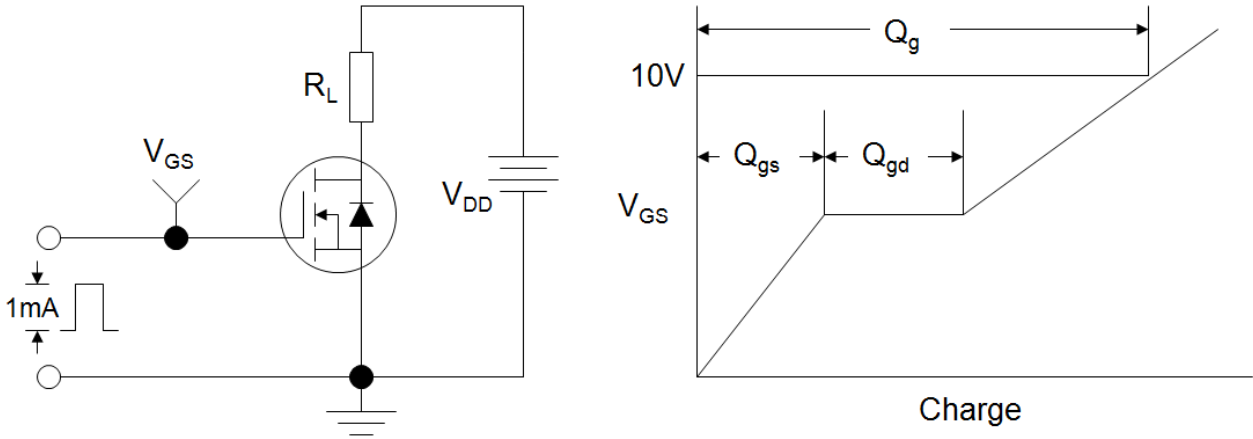

Figure B: Resistive Switching Test Circuit and Waveform

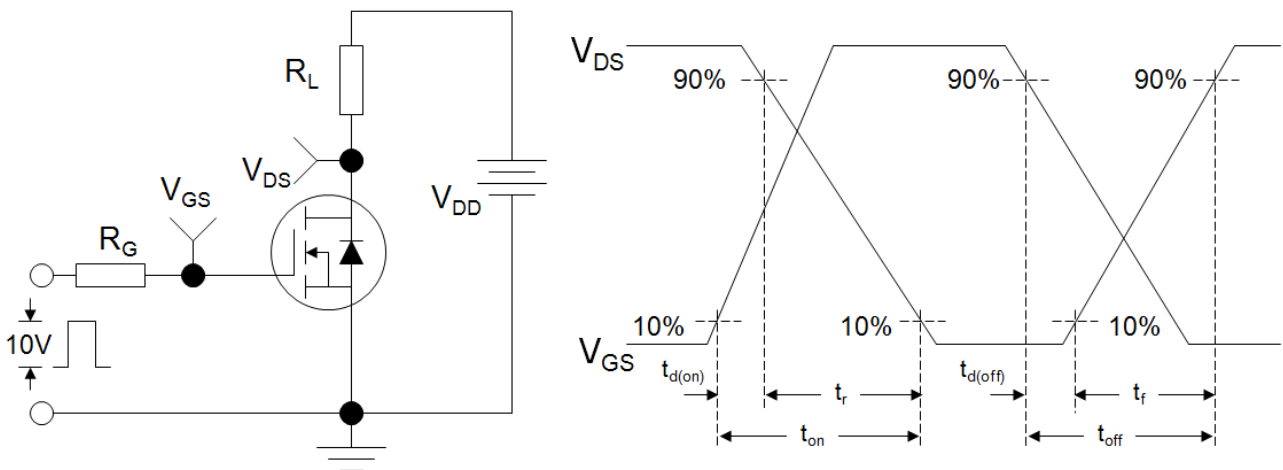
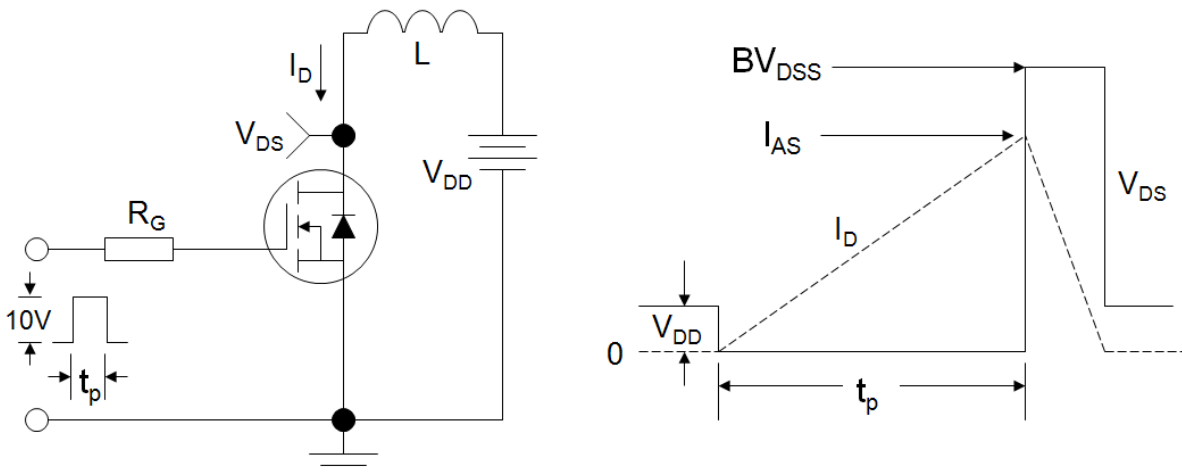

Figure C: Unclamped Inductive Switching Test Circuit and Waveform



•Dimensions (TO-220F)

UNIT:mm

SYMBOL	min	max	SYMBOL	min	max
A	4.20	4.80	E1	8.30	8.70
A1	2.50	2.90	e	2.40	2.70
A2	2.90	3.30	e1	4.95	5.25
b	0.40	0.80	F	2.50	2.90
b1	1.10	1.50	L	13.00	14.00
c	0.50	0.70	L1	3.00	4.00
D	9.80	10.60	∅P	2.90	3.50
E	14.60	15.60			

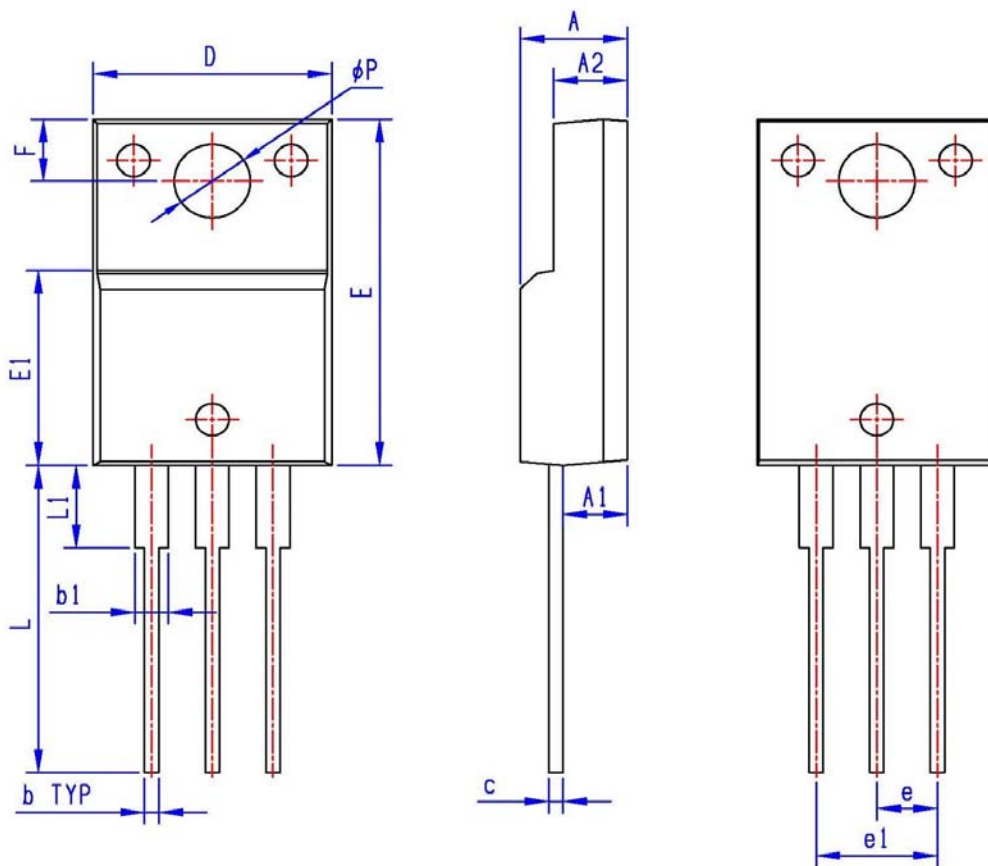

●Dimensions (TO-220)

UNIT:mm

SYMBOL	min	max	SYMBOL	min	max
A	4.25	4.85	B1	2.60	3.00
A1	2.30	3.00	e	2.40	2.70
A2	1.20	1.40	e1	4.95	5.25
b	0.60	0.90	L	12.60	14.40
b1	1.10	1.70	L1	2.40	4.00
c	0.40	0.70	∅P	3.50	3.90
D	9.80	10.60			
B	15.20	16.20			

