

•General Description



The SJ MOSFET LH65R170 has the low $R_{DS(on)}$, low gate charge, fast switching and excellent avalanche characteristics. This device offers extremely fast and robust body diode, and is suitable for telecom and power supplies.

•Features

- Much lower $R_{on} \cdot A$ performance for On-state efficiency
- Much lower FOM for fast switching efficiency

•Application

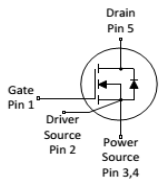
- LED/LCD/PDP TV and monitor Lighting
- Solar/Renewable/UPS-Micro Inverter System
- Power Supplies

	<p>$V_{DS} = 650V$</p> <p>$R_{DS(ON)} = 170m\Omega$</p> <p>$I_D = 20A$</p>
	<p>■ RoHS COMPLIANT</p>
	<p>DFN8*8</p>

•Ordering Information:

Part number	LH65R170
Package	DFN8*8
Basic ordering unit (pcs)	5000
Normal Package Material Ordering Code	LH65R170D8-DFN8*8-TAP
Halogen Free Ordering Code	LH65R170D8-DFN8*8-TAP-HF

•Absolute Maximum Ratings (TC = 25°C)

PARAMETER	SYMBOL	Value	UNIT
Drain-Source Breakdown Voltage	BV_{DSS}	650	V
Gate-Source Voltage	V_{GS}	± 30	V
Continuous Drain Current	I_D	20	A
	TC = 100°C	12	
Pulsed drain current (TC = 25°C, tp limited by Tjmax) ¹	I_D pulse	60	A
Single Pulse Avalanche Energy ¹	E_{AR}	3.5	A
Single Pulse Avalanche Energy ²	E_{AS}	484	mJ
Repetitive Avalanche Energy ¹	E_{AR}	0.7	mJ
Power Dissipation(TC=25°C)	P_D	34	W
Operating Temperature and Storage Temperature Range	T_J/T_{STG}	-55~+150	°C
MOSFET dv/dt ruggedness, $V_{DS}=0 \dots 480V$	dv/dt	50	V/ns
Reverse diode dv/dt, $V_{DS}=0 \dots 480V, I_{SD} \leq I_D$	dv/dt	15	V/ns

●Electronic Characteristics

PARAMETER	SYMBOL	TEST CONDITION	MIN	TYP	MAX	UNIT
Drain-Source Breakdown Voltage	BV_{DSS}	$V_{GS}=0V, I_D=250\mu A$	650	--	--	V
Gate Threshold Voltage	$V_{GS(TH)}$	$V_{DS}=V_{GS}, I_D=250\mu A$	2.5	--	4.5	V
Drain-source On Resistance ³	$R_{DS(ON)}$	$V_{GS}=10V, I_D=7A$	--	150	170	mΩ
Drain-Source Leakage Current	I_{DSS}	$V_{DS}=650V, V_{GS}=0V, T_J=25^\circ C$	--	--	1	μA
		$V_{DS}=650V, V_{GS}=0V, T_J=125^\circ C$	--	--	100	
Gate-Source Leakage Current	I_{GSS}	$V_{GS}=\pm 30$	--	--	±100	nA
Forward Transconductance ³	R_G	f=1.0MHz open drain	--	--	12	Ω
Input Capacitance	C_{iss}	$V_{GS}=0V,$ $V_{DD}=520V$ $f=1.0MHz$	--	1724	--	pF
Output Capacitance	C_{oss}		--	61	--	
Reverse transfer Capacitance	C_{rss}		--	6	--	
Turn-on delay time	$T_d(on)$	$I_D=20A,$ $V_{DD}=400V$ $R_G=25\Omega$	--	15	--	nS
Rise time	T_r		--	59	--	
Turn -Off Delay Time	$T_d(off)$		--	121	--	
Fall time	T_f		--	44	--	
Total Gate Charge	Q_g	$I_D=20A,$ $V_{DS}=520V$ $V_{GS}=10V$	--	38.5	---	nC
Gate-to-Source Charge	Q_{gs}		--	8	--	
Gate-to-Drain Charge	Q_{gd}		--	15	---	
Continuous Diode Forward Current	I_S		--	--	20	A
Pulsed Diode Forward Current	I_{SM}		--	--	60	A
Diode Forward Voltage	V_{SD}	$T_J=25^\circ C, I_S=20A$ $V_{GS}=0V$	--	0.9	1.2	V
Reverse Recovery Time	t_{rr}	$V_{RR}=400V,$ $I_f=I_S$ $di_F/dt=100A/\mu s$	--	423	--	ns
Reverse Recovery Charge	Q_{rr}		--	5.3	--	μC
Peak Reverse Recovery Current	I_{RRM}		--	25	--	A

●Thermal Characteristics

PARAMETER	SYMBOL	MAX		UNIT
		TO-220F	TO-220	
Thermal Resistance Junction-case	R_{thJC}	3.7	0.83	°C/W
Thermal Resistance Junction-ambient	R_{thJA}	80	62	°C/W

Notes:

- 1.Repetitive Rating: Pulse width limited by maximum junction temperature.
2. $I_{AS}=1.8A, V_{DD}=50V, R_G=25\Omega$, Starting $T_J=25^\circ C$
3. Pulse Test : Pulse width $\leq 300\mu s$, Duty cycle $\leq 2\%$

● Typical Characteristics $T_J=25^\circ\text{C}$, unless otherwise noted

Figure 1. Output Characteristics

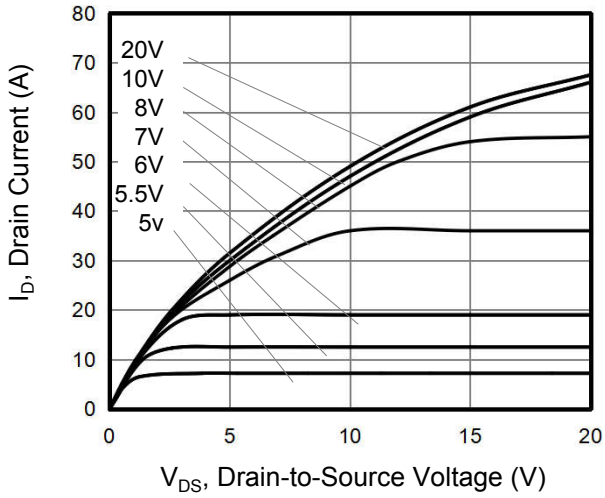

Figure 2. Transfer Characteristics

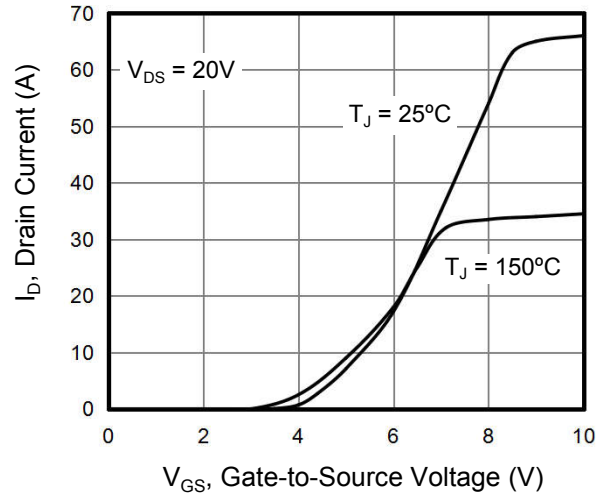

Figure 3. On-Resistance vs. Drain Current

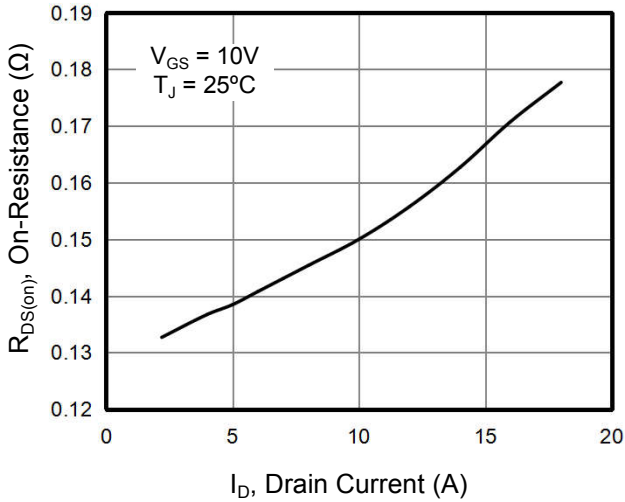

Figure 4. Capacitance

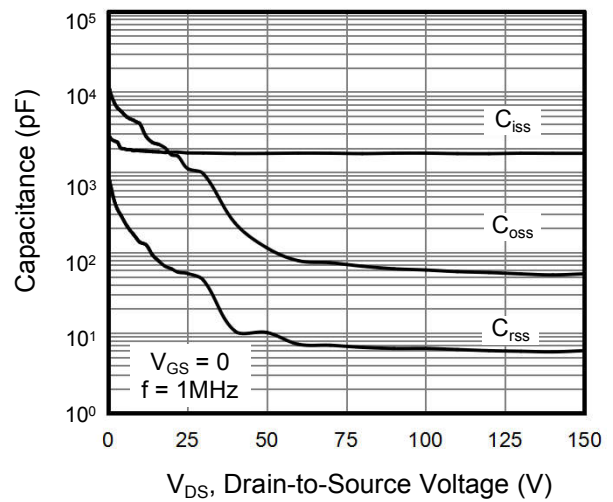

Figure 5. Gate Charge

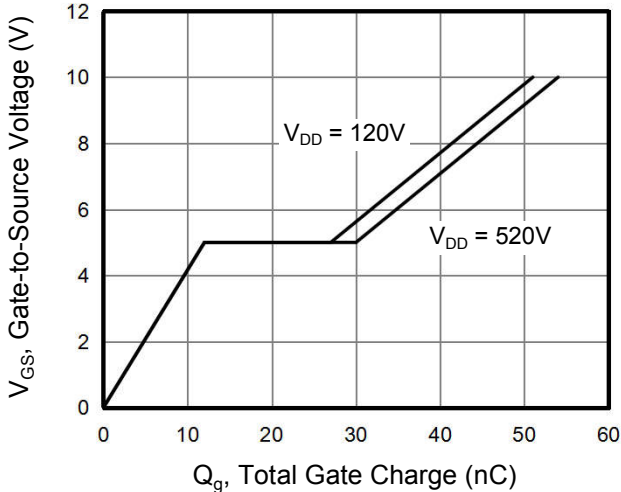
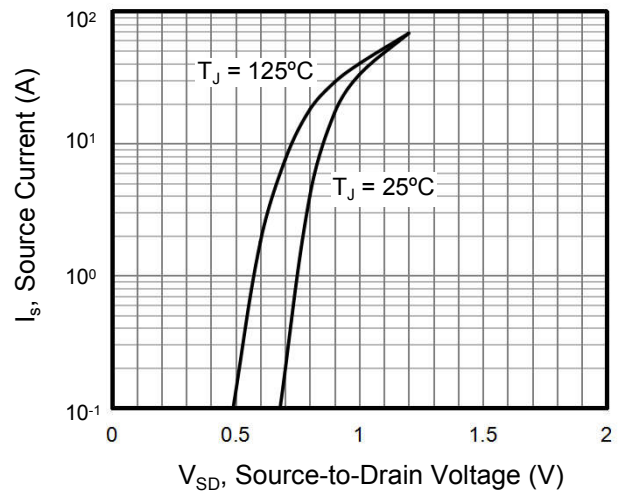

Figure 6. Body Diode Forward Voltage



• Typical Characteristics (Cont.)

Figure 7. On-Resistance vs. Junction Temperature

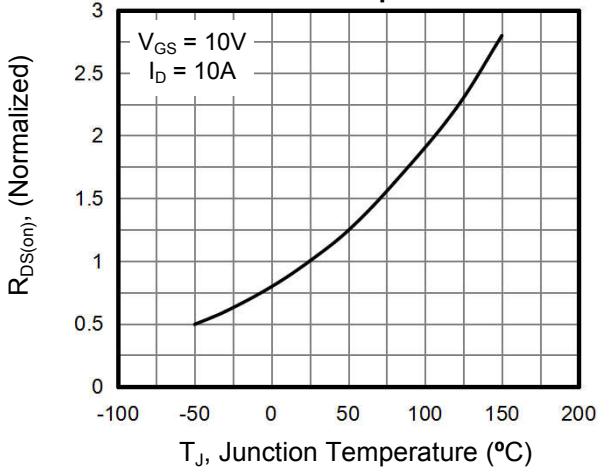

Figure 8. Threshold Voltage vs. Junction Temperature

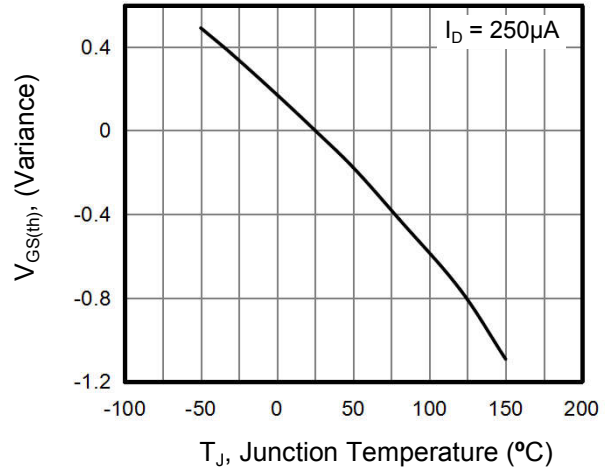

Figure 9. Transient Thermal Impedance

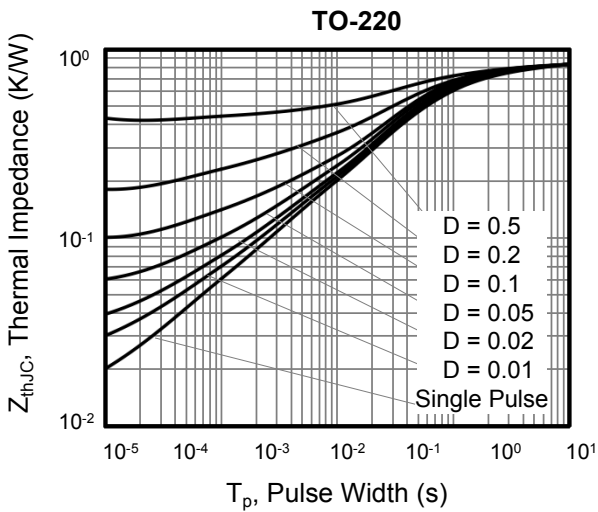

Figure 10. Transient Thermal Impedance

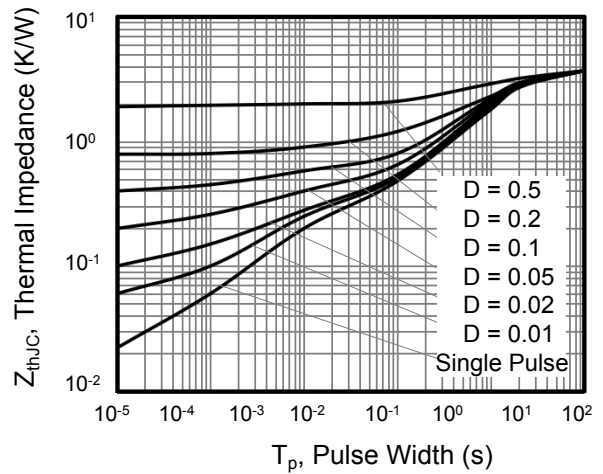

Figure 12. Safe operation area for TO-220

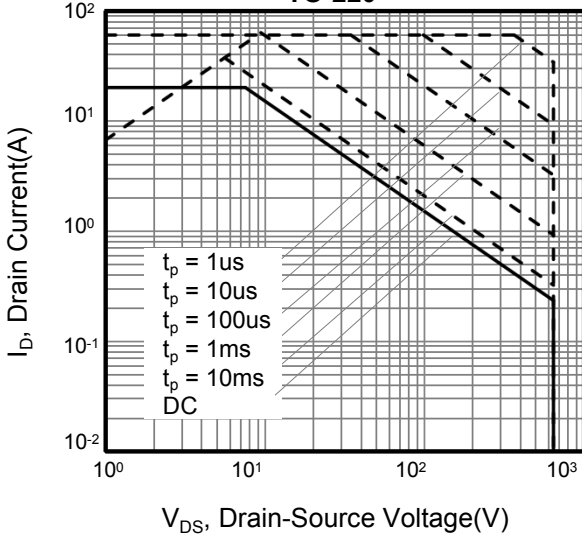
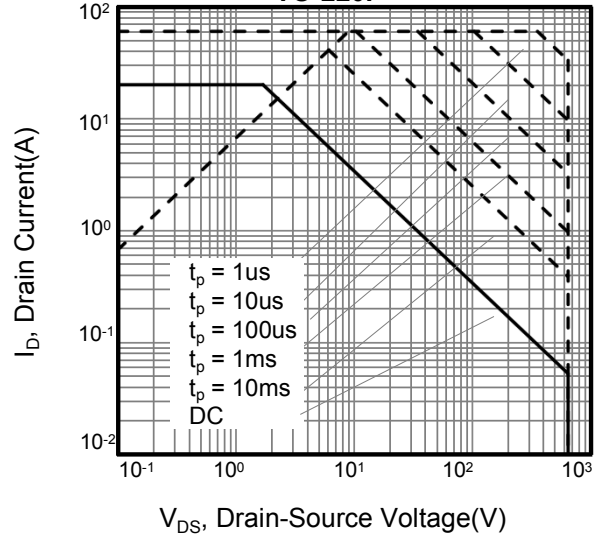

Figure 13. Safe operation area for TO-220F



● Test Circuit and Waveform

Figure A: Gate Charge Test Circuit and Waveform

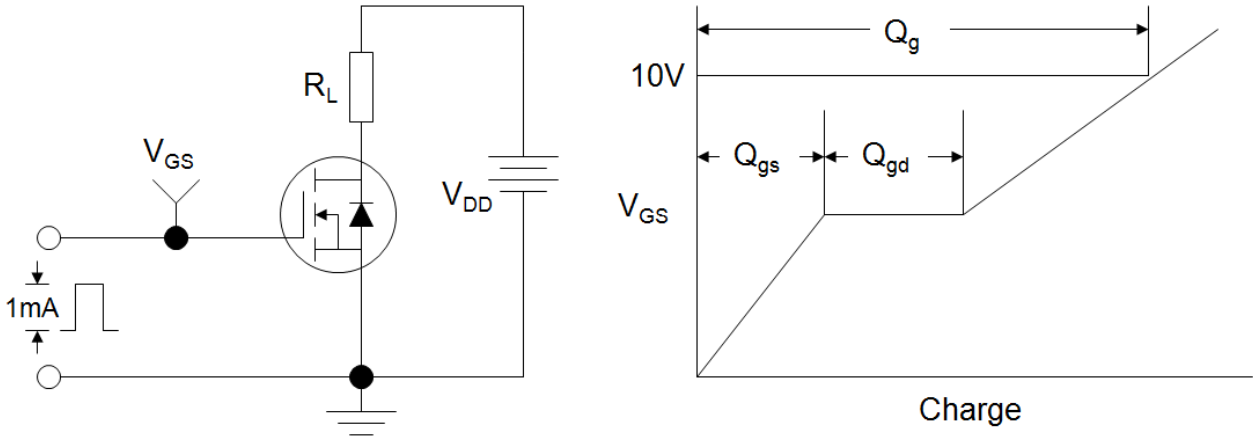

Figure B: Resistive Switching Test Circuit and Waveform

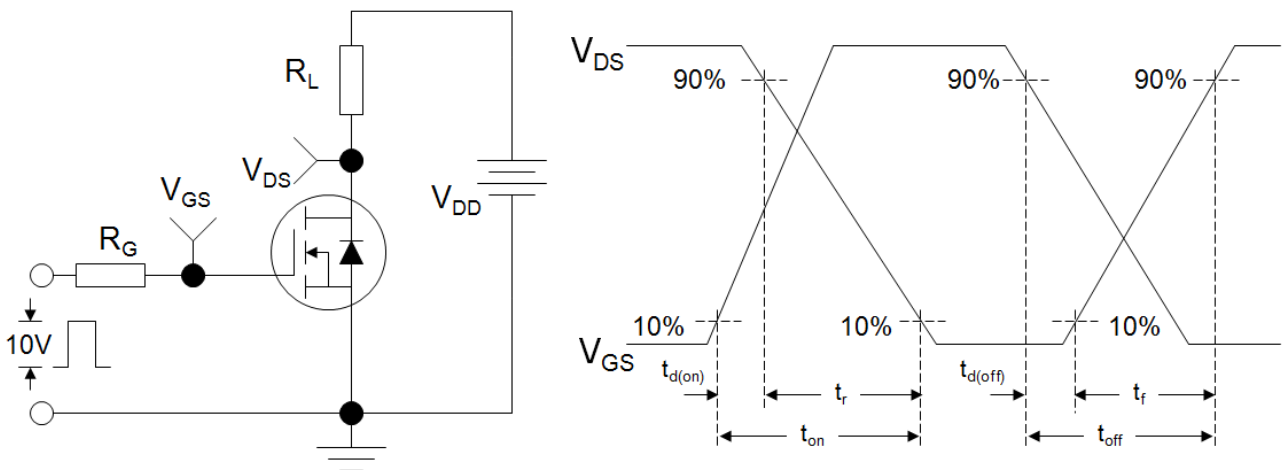
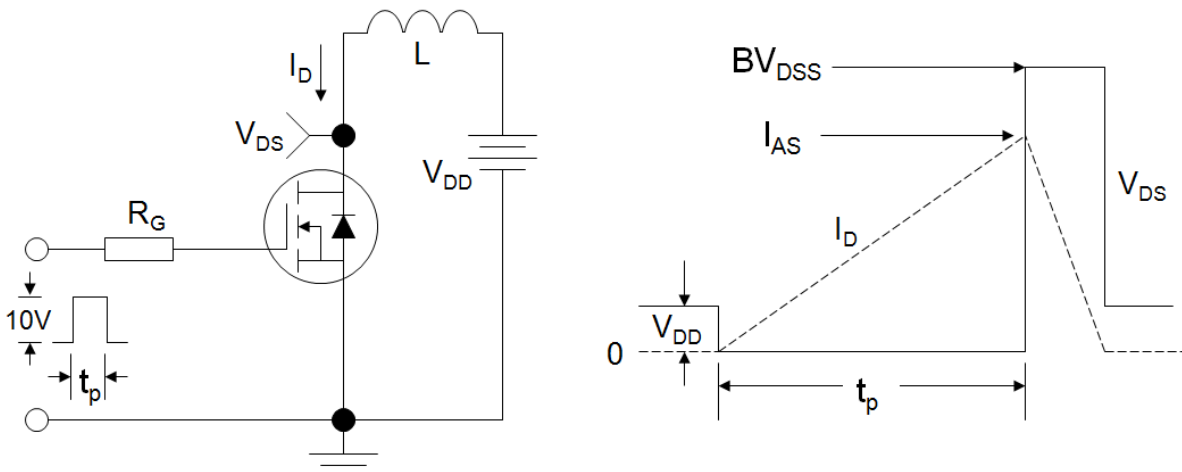

Figure C: Unclamped Inductive Switching Test Circuit and Waveform



•Dimensions (DFN8*8)

Unit: mm

SYMBOL	min	max	SYMBOL	min	max
A	0.80	1.10	E1	4.20	4.50
A1	0.00	0.08	e	2.00TYP	
b	0.90	1.10	K	2.75REF	
c	0.20REF		L	1.20	2.00
D	7.85	8.15	H	0.40	0.60
D1	7.05	7.35	s	0.35	0.45
E	7.85	8.15			

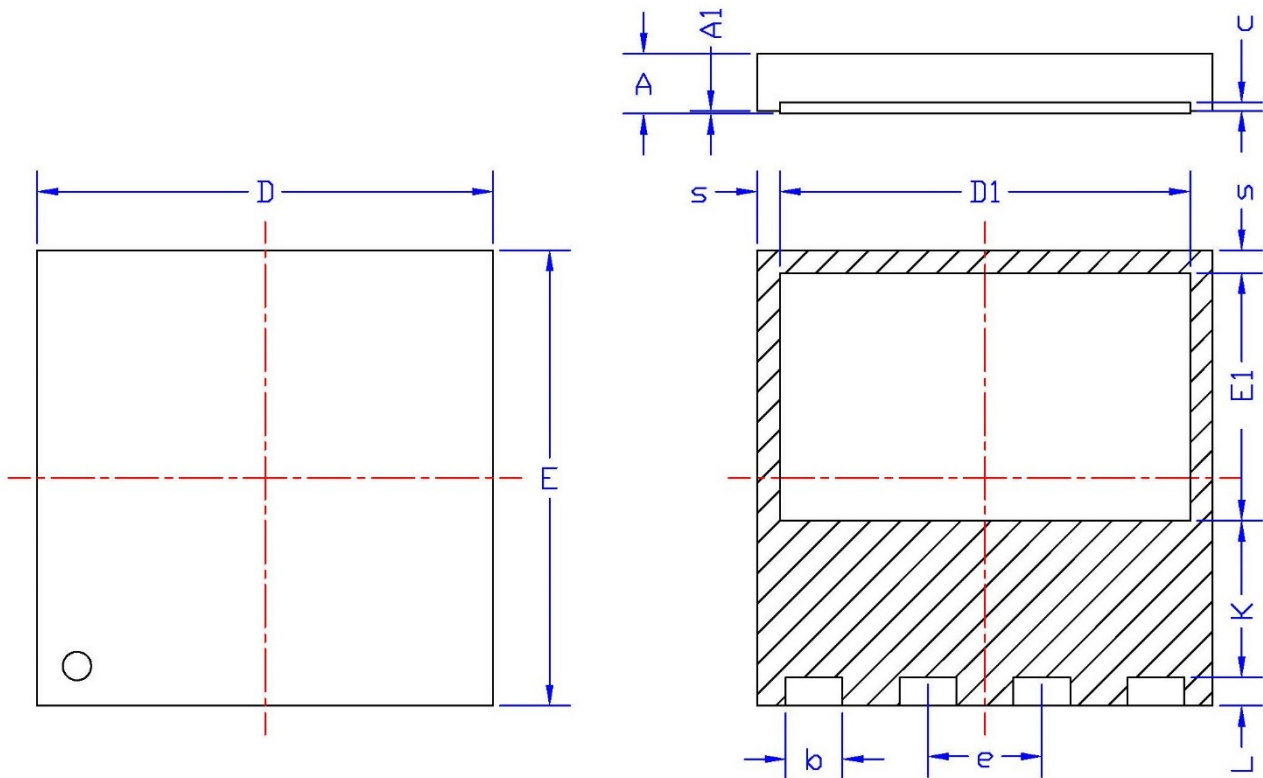

● Classification Profile

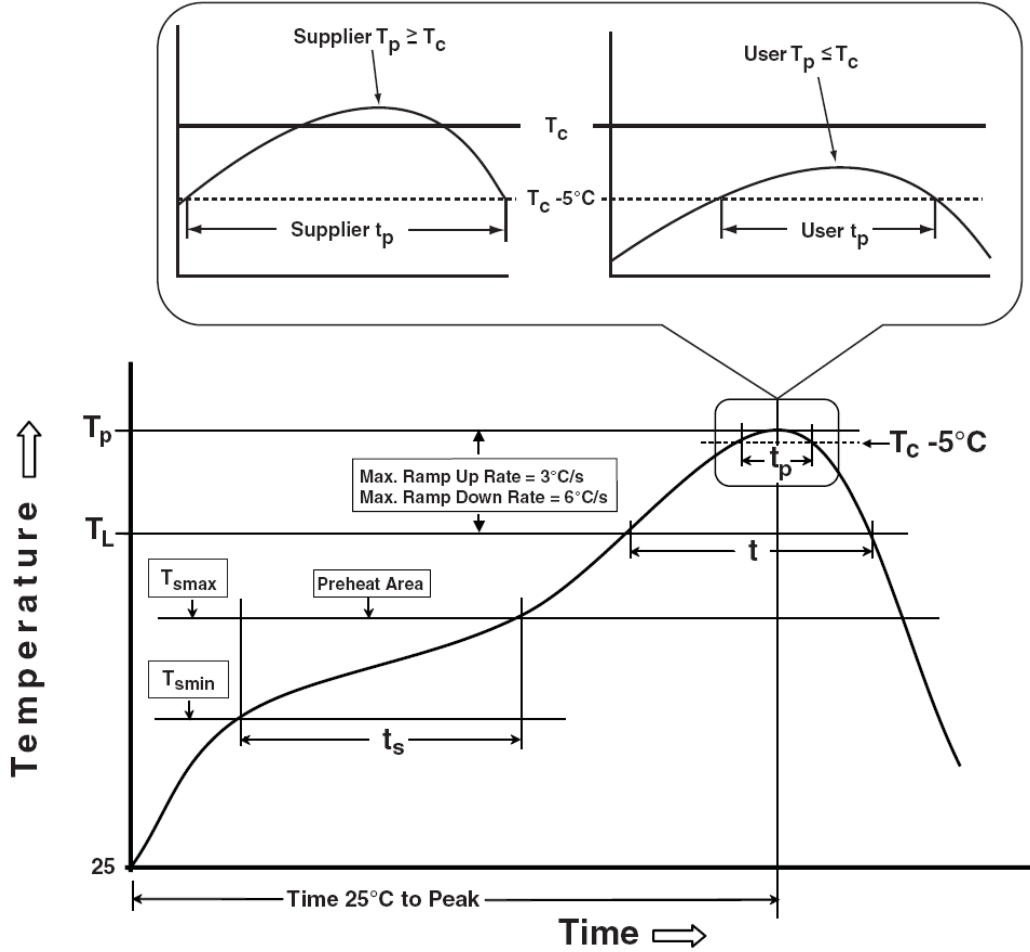

● Classification Reflow Profiles

Profile Feature	Sn-Pb Eutectic Assembly	Pb-Free Assembly
Preheat & Soak Temperature min (T_{smin}) Temperature max (T_{smax}) Time (T_{smin} to T_{smax}) (t_s)	100 °C 150 °C 60-120 seconds	150 °C 200 °C 60-120 seconds
Average ramp-up rate (T_{smax} to T_p)	3 °C/second max.	3°C/second max.
Liquidous temperature (T_L) Time at liquidous (t_L)	183 °C 60-150 seconds	217 °C 60-150 seconds
Peak package body Temperature (T_p)*	See Classification Temp in table 1	See Classification Temp in table 2
Time (t_p)** within 5°C of the specified classification temperature (T_c)	20** seconds	30** seconds
Average ramp-down rate (T_p to T_{smax})	6 °C/second max.	6 °C/second max.
Time 25°C to peak temperature	6 minutes max.	8 minutes max.
* Tolerance for peak profile Temperature (T_p) is defined as a supplier minimum and a user maximum. ** Tolerance for time at peak profile temperature (t_p) is defined as a supplier minimum and a user maximum.		

 Table 1. SnPb Eutectic Process – Classification Temperatures (T_c)

Package Thickness	Volume mm ³ <350	Volume mm ³ ≥350
<2.5 mm	235 °C	220 °C
≥2.5 mm	220 °C	220 °C

 Table 2. Pb-free Process – Classification Temperatures (T_c)

Package Thickness	Volume mm ³ <350	Volume mm ³ 350-2000	Volume mm ³ >2000
<1.6 mm	260 °C	260 °C	260 °C
1.6 mm – 2.5 mm	260 °C	250 °C	245 °C
≥2.5 mm	250 °C	245 °C	245 °C

Reliability Test Program

Test Item	Method	Description
Solder ability	JESD-22, B012	5 SEC., 245°C
HOLT	JESD-22, A108	1000 HRs, Bias@125°C
PCT	JESD-22, A102	168 HRs, 100% RH, 2ATM, 121°C
TCT	JESD-22, A104	500 Cycles, -65 ~ 150°C