

•General Description

The SJ MOSFET LH65R360 has the low $R_{DS(on)}$, low gate charge, fast switching and excellent avalanche characteristics. This device offers extremely fast and robust body diode, and is suitable for telecom and power supplies.

•Features

- Much lower $R_{on} \cdot A$ performance for On-state efficiency
- Much lower FOM for fast switching efficiency

•Application

- LED/LCD/PDP TV and monitor Lighting
- Solar/Renewable/UPS-Micro Inverter System
- Power Supplies

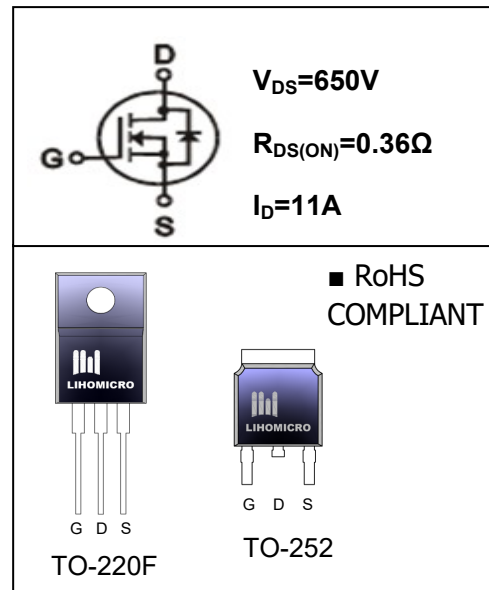
•Ordering Information:

Part number	LH65R360	LH65R360
Package	TO-252	TO-220F
Basic ordering unit (pcs)	2500	1000
Normal Package Material Ordering Code	LH65R360T5-T0252-TAP	LH65R360F-T0220F-TU
Halogen Free Ordering Code	LH65R360T5-T0252-TAP-HF	LH65R360F-T0220F-TU-HF

•Absolute Maximum Ratings (TC =25°C)

PARAMETER	SYMBOL	Value	UNIT
Drain-Source Breakdown Voltage	BV_{DSS}	650	V
Gate-Source Voltage	V_{GS}	±30	V
Continuous Drain Current	I_D	TC = 25°C	11
		TC = 100°C	6.6
Pulsed drain current (TC = 25°C, tp limited by Tjmax) ¹	I_D pulse	33	A
Single Pulse Avalanche Energy	I_{AR}	1.8	A
Single Pulse Avalanche Energy ²	E_{AS}	215	mJ
Repetitive Avalanche Energy ²	E_{AR}	0.32	mJ
Power Dissipation(TC=25°C)	P_D	TO-252: 82	TO-220F: 31
Operating Temperature and Storage Temperature Range	T_J/T_{STG}	-55~+150	
Reverse diode dv/dt ³	dv/dt	15	V/ns
Maximum diode commutation speed ³	di_f/dt	500	V/ns

●Electronic Characteristics

PARAMETER	SYMBOL	TEST CONDITION	MIN	TYP	MAX	UNIT
Drain-Source Breakdown Voltage	BV_{DSS}	$V_{GS}=0V, I_D=250\mu A$	650	--	--	V
Gate Threshold Voltage	$V_{GS(TH)}$	$V_{DS}=V_{GS}, I_D=250\mu A$	2.5	--	4.5	V
Drain-source On Resistance ³	$R_{DS(ON)}$	$V_{GS}=10V, I_D=5.5A$	--	0.31	0.36	Ω
Drain-Source Leakage Current	I_{DSS}	$V_{DS}=650V, V_{GS}=0V, T_J=25^\circ C$	--	--	1	μA
		$V_{DS}=650V, V_{GS}=0V, T_J=125^\circ C$	--	--	100	
Gate-Source Leakage Current	I_{GSS}	$V_{GS}=\pm 30$	--	--	± 100	nA
Forward Transconductance ³	R_G	f=1.0MHz open drain	--	--	18	Ω
Input Capacitance	C_{iss}	$V_{GS}=0V,$ $V_{DS}=100V$ f = 1.0MHz	--	808	--	pF
Output Capacitance	C_{oss}		--	33	--	
Reverse transfer Capacitance	C_{rss}		--	2.0	--	
Turn -Off Delay Time	$T_d(off)$	$V_{DD}=400V,$ $I_D=11.0A$ $R_G=25\Omega$	--	145	--	ns
Turn-on delay time	$T_d(on)$		--	70	--	
Rise time	T_r		--	70	--	
Fall time	T_f		--	59	--	
Total Gate Charge	Q_g	$I_D=11A,$ $V_{DS}=520V$ $V_{GS}=10V$	--	22	---	nC
Gate-to-Source Charge	Q_{gs}		--	4	--	
Gate-to-Drain Charge	Q_{gd}		--	8	---	
Continuous Diode Forward Current	I_s		--	--	11	A
Pulsed Diode Forward Current ¹	I_{SM}		--	--	33	A
Diode Forward Voltage	V_{SD}	$T_J=25^\circ C, I_s=5.5A$ $V_{GS}=0V$	--	0.9	1.2	V
Reverse Recovery Time	trr	$V_{RR}=400V,$ If=Is diF/dt=100A/ μs	--	377	--	ns
Reverse Recovery Charge	Qrr		--	3.4	--	μC
Peak Reverse Recovery Current	I_{RRM}		--	17.8	--	A

●Thermal Characteristics

PARAMETER	SYMBOL	MAX		UNIT
		TO-252	TO-220F	
Thermal Resistance Junction-case	R_{thJC}	1.51	4	$^\circ C/W$
Thermal Resistance Junction-ambient	R_{thJA}	62	80	$^\circ C/W$

Notes:

- 1.Repetitive Rating: Pulse width limited by maximum junction temperature.
2. $I_{AS}=1.8A, V_{DD}=50V, R_G=25\Omega, \text{Starting } T_J=25^\circ C$
3. Pulse Test : Pulse width $\leq 300\mu s, \text{Duty cycle } \leq 2\%$

• Typical Characteristics $T_J=25^\circ\text{C}$, unless otherwise noted

Figure 1. Output Characteristics

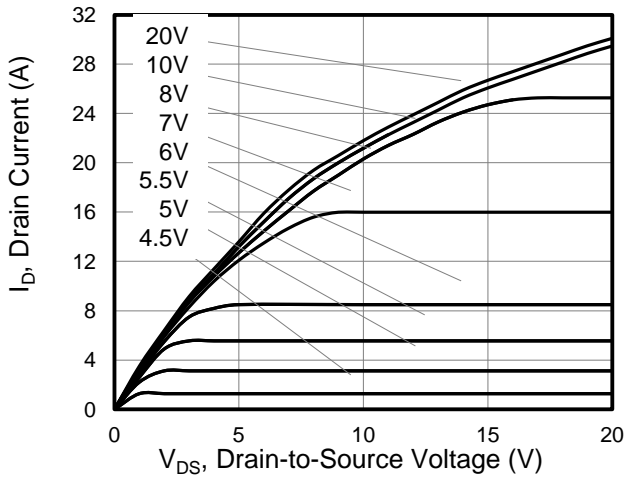

Figure 2. Transfer Characteristics

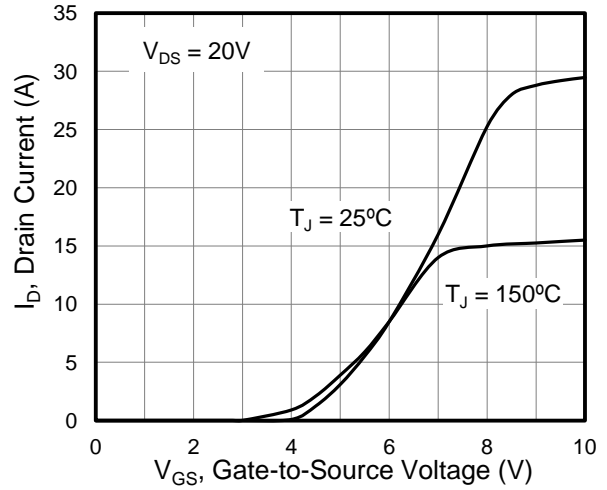

Figure 3. On-Resistance vs. Drain Current

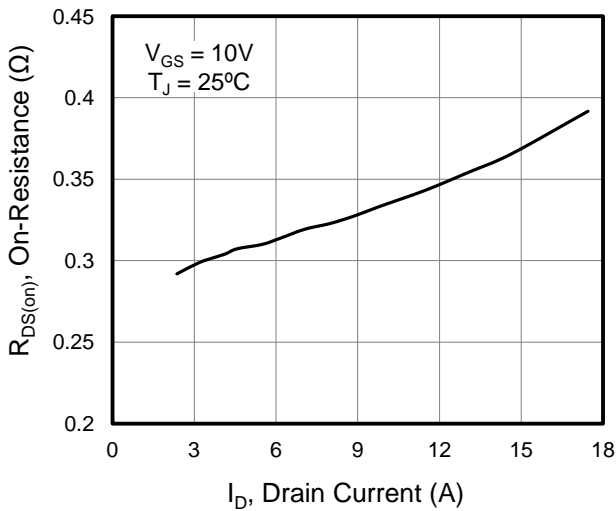

Figure 4. Capacitance

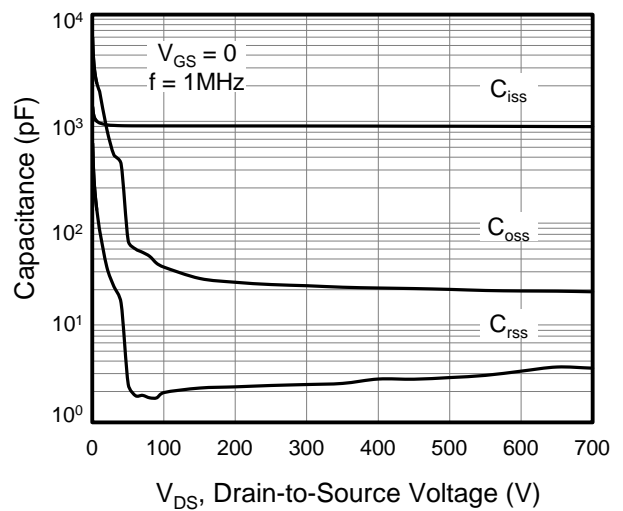

Figure 5. Gate Charge

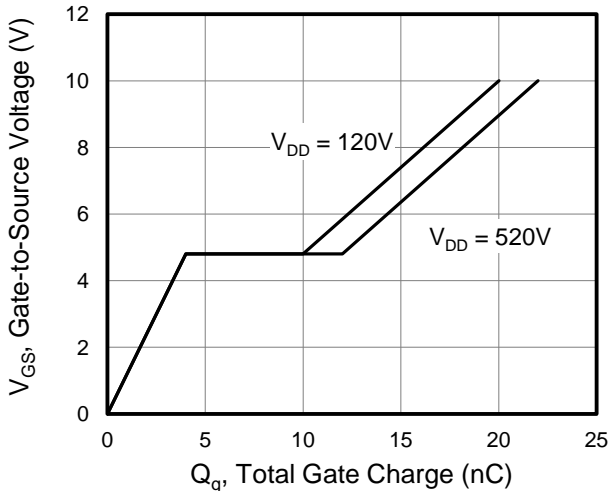
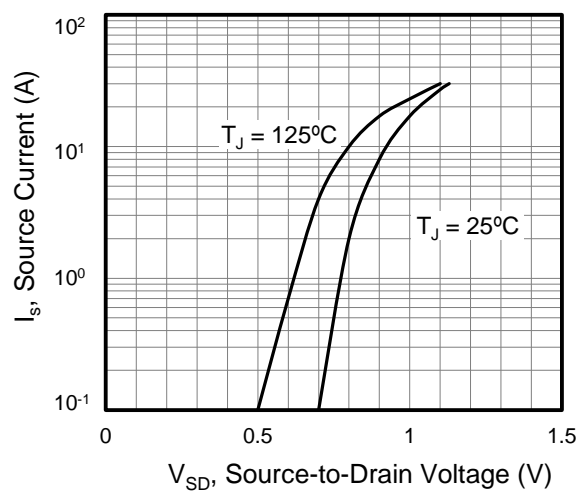

Figure 6. Body Diode Forward Voltage



● Typical Characteristics(Cont.)

Figure 7. On-Resistance vs. Junction Temperature

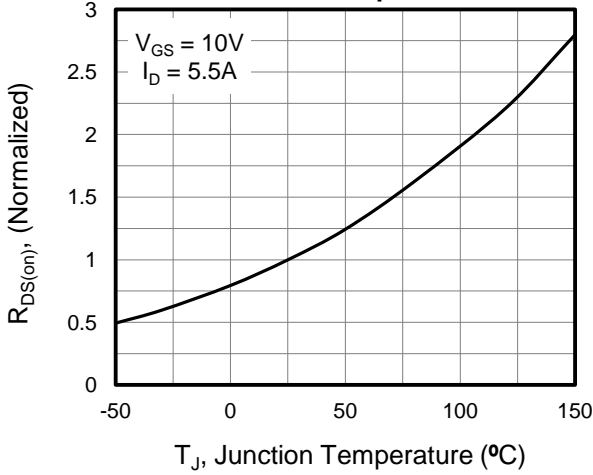

Figure 8. Breakdown voltage vs. Junction Temperature

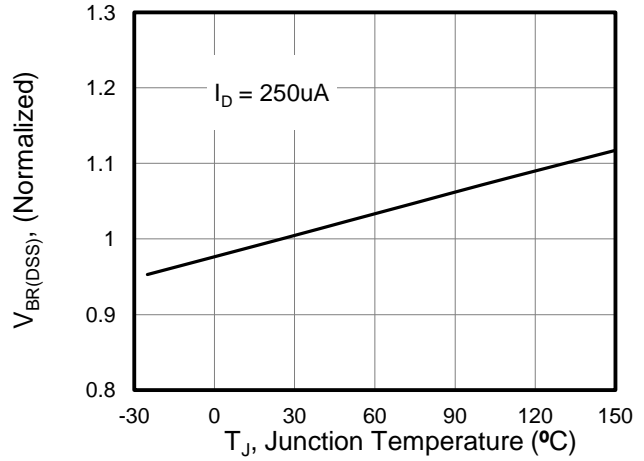

Figure 9. Transient Thermal Impedance

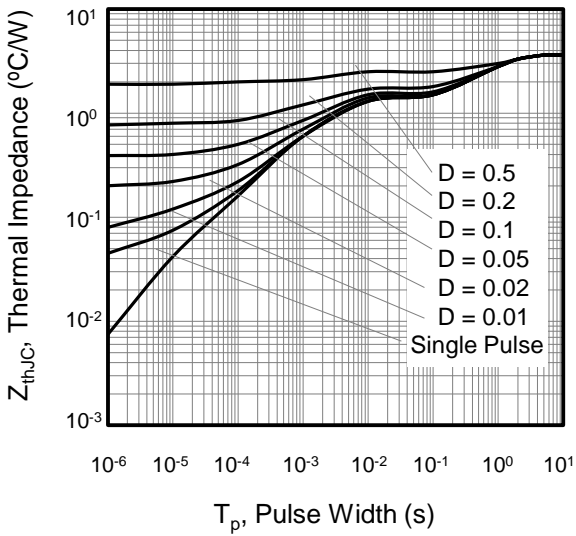
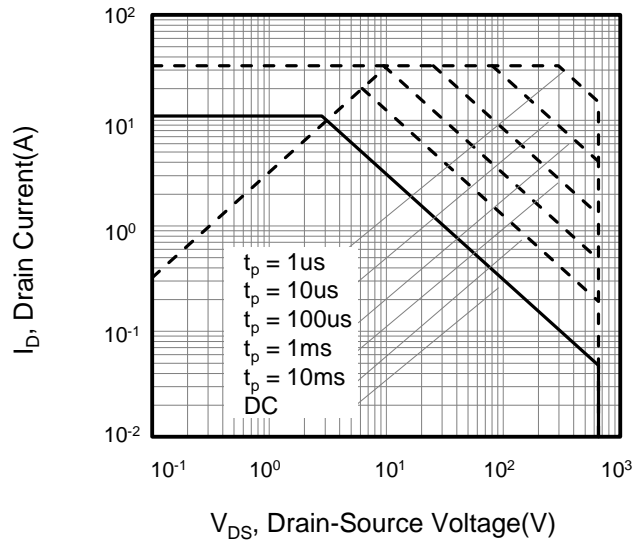

Figure 10. Safe operation area



• Test Circuit and Waveforms

Figure A: Gate Charge Test Circuit and Waveform

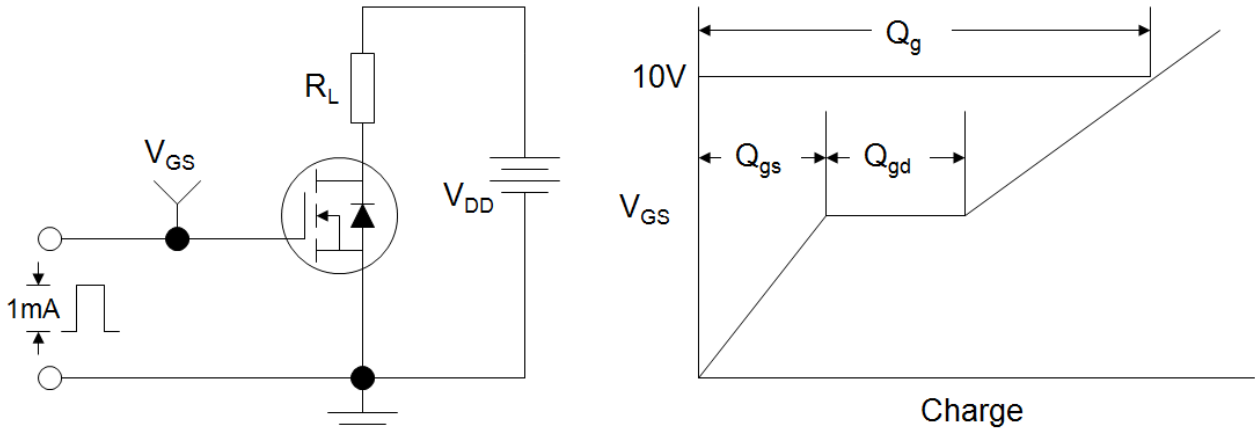

Figure B: Resistive Switching Test Circuit and Waveform

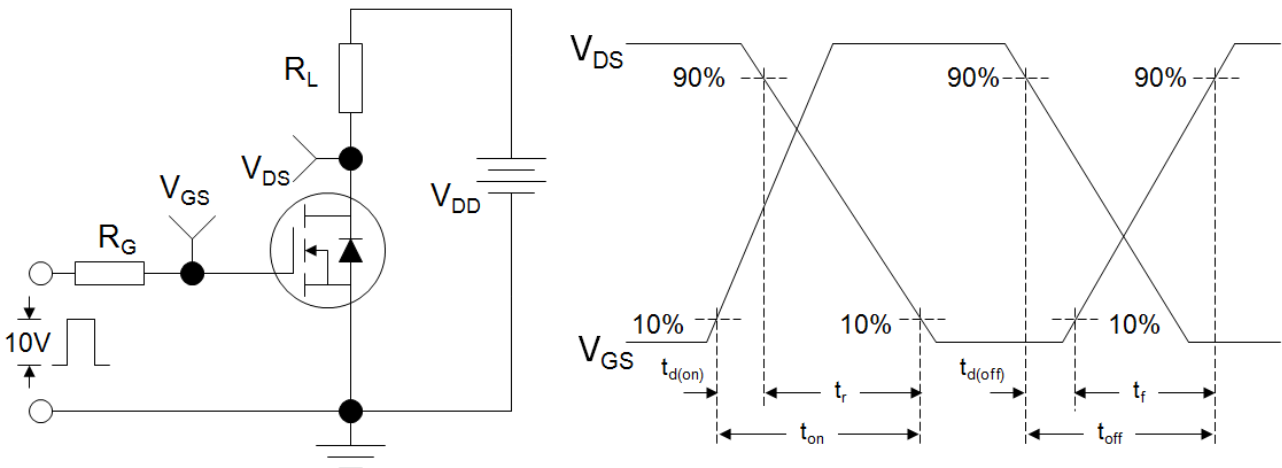
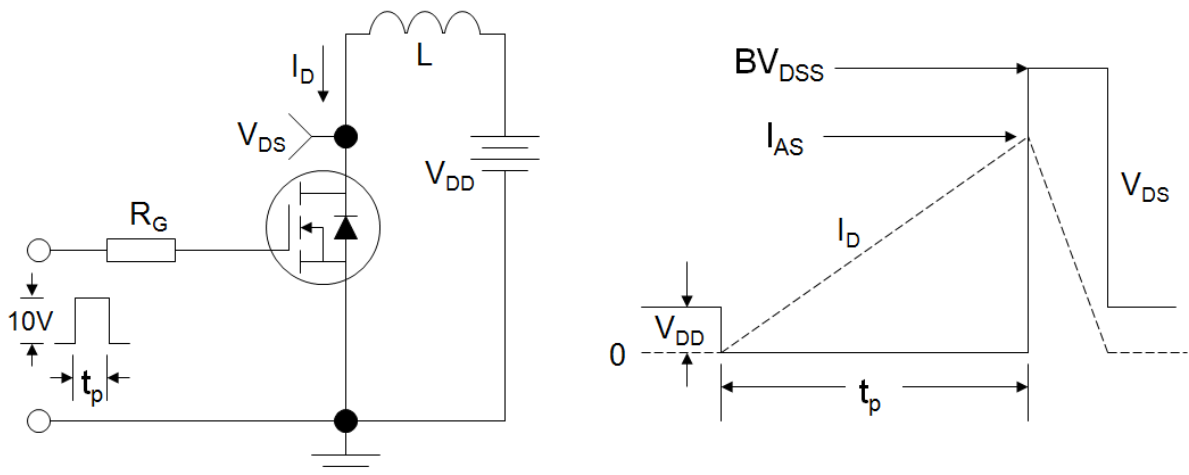

Figure C: Unclamped Inductive Switching Test Circuit and Waveform



•Dimensions (TO-252)

UNIT:mm

SYMBOL	min	max	SYMBOL	min	max
A	2.10	2.50	L2	0.60	1.20
b	0.50	0.90	L3	1.20	1.80
b1	0.70	1.20	B	0.80	1.30
b2	0.40	0.70	C	0.40	0.70
D	6.20	6.80	D1	5.10	5.60
E	5.80	6.40	e1	2.10	2.45
L	3.60	4.60	e2	4.40	4.80
L1	0.80	1.60			

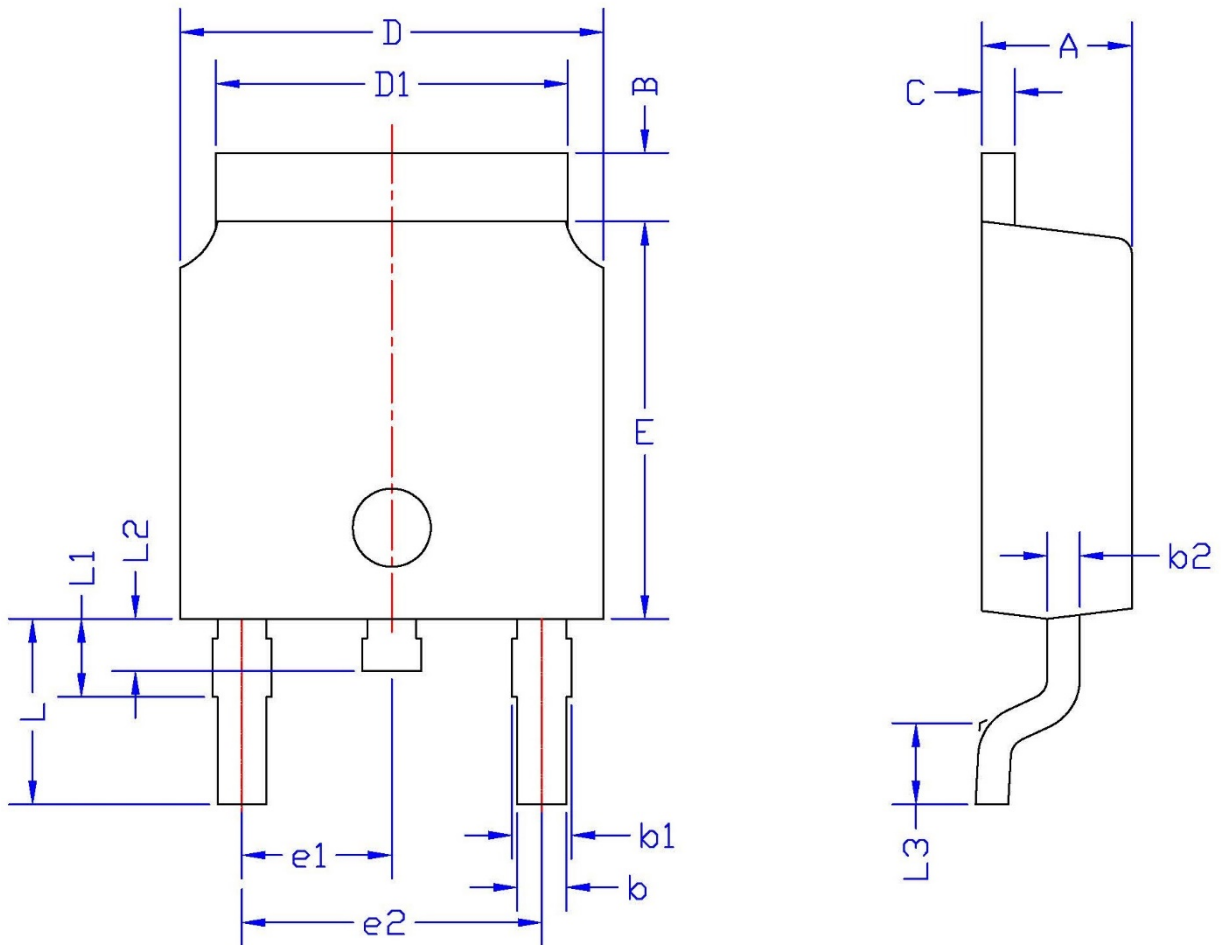

•Dimensions (TO-220F)

UNIT:mm

SYMBOL	min	max	SYMBOL	min	max
A	4.20	4.80	E1	8.30	8.70
A1	2.50	2.90	e	2.40	2.70
A2	2.90	3.30	e1	4.95	5.25
b	0.40	0.80	F	2.50	2.90
b1	1.10	1.50	L	13.00	14.00
c	0.50	0.70	L1	3.00	4.00
D	9.80	10.60	∅P	2.90	3.50
E	14.60	15.60			

