

**•General Description**

The SJ MOSFET LH70R360 has the low  $R_{DS(on)}$ , low gate charge, fast switching and excellent avalanche characteristics. This device offers extremely fast and robust body diode, and is suitable for telecom and power supplies.

**•Features**

- Much lower  $R_{on} \cdot A$  performance for On-state efficiency
- Much lower FOM for fast switching efficiency

**•Application**

- LED/LCD/PDP TV and monitor Lighting
- Solar/Renewable/UPS-Micro Inverter System
- Power Supplies

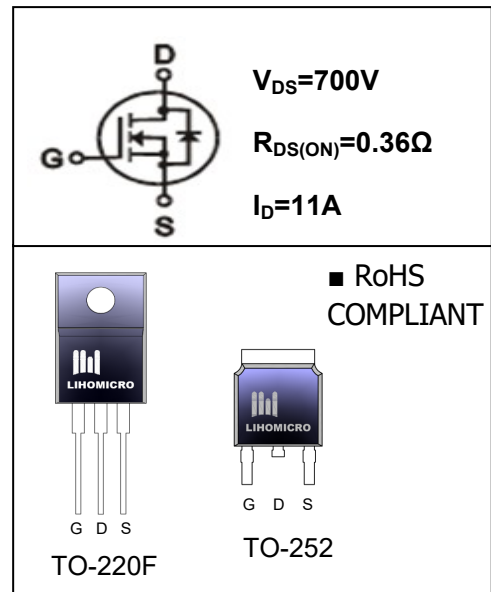
**•Ordering Information:**

Part number	LH70R360	LH70R360
Package	TO-252	TO-220F
Basic ordering unit (pcs)	2500	1000
Normal Package Material Ordering Code	LH70R360T5-T0252-TAP	LH70R360F-T0220F-TU
Halogen Free Ordering Code	LH70R360T5-T0252-TAP-HF	LH70R360F-T0220F-TU-HF

**•Absolute Maximum Ratings (TC =25°C)**

PARAMETER	SYMBOL	Value	UNIT
Drain-Source Breakdown Voltage	$BV_{DSS}$	700	V
Gate-Source Voltage	$V_{GS}$	±30	V
Continuous Drain Current	$I_D$	TC = 25°C	11
		TC = 100°C	6.6
Pulsed drain current (TC = 25°C, tp limited by Tjmax) <sup>1</sup>	$I_D$ pulse	33	A
Single Pulse Avalanche Energy	$E_{AR}$	1.8	A
Single Pulse Avalanche Energy <sup>2</sup>	$E_{AS}$	215	mJ
Repetitive Avalanche Energy <sup>2</sup>	$E_{AR}$	0.32	mJ
Power Dissipation(TC=25°C)	$P_D$	TO-252: 82	TO-220F: 31
Operating Temperature and Storage Temperature Range	$T_J/T_{STG}$	-55~+150	
Reverse diode $dv/dt$ <sup>3</sup>	$dv/dt$	15	V/ns
Maximum diode commutation speed <sup>3</sup>	$di_f/dt$	500	V/ns

**●Electronic Characteristics**

PARAMETER	SYMBOL	TEST CONDITION	MIN	TYP	MAX	UNIT
Drain-Source Breakdown Voltage	$BV_{DSS}$	$V_{GS} = 0V, I_D = 250\mu A$	700	--	--	V
Gate Threshold Voltage	$V_{GS(TH)}$	$V_{DS} = V_{GS}, I_D = 250\mu A$	2.5	--	4.5	V
Drain-source On Resistance <sup>3</sup>	$R_{DS(ON)}$	$V_{GS} = 10V, I_D = 5.5V$	--	0.31	0.36	$\Omega$
Drain-Source Leakage Current	$I_{DSS}$	$V_{DS} = 700V, V_{GS} = 0V, T_J = 25^\circ C$	--	--	1	$\mu A$
		$V_{DS} = 700V, V_{GS} = 0V, T_J = 125^\circ C$	--	--	100	
Gate-Source Leakage Current	$I_{GSS}$	$V_{GS} = \pm 30$	--	--	$\pm 100$	nA
Forward Transconductance <sup>3</sup>	$R_G$	f=1.0MHz open drain	--	--	18	$\Omega$
Input Capacitance	$C_{iss}$	$V_{GS} = 0V,$ $V_{DS} = 100V$ f = 1.0MHz	--	808	--	pF
Output Capacitance	$C_{oss}$		--	33	--	
Reverse transfer Capacitance	$C_{rss}$		--	2.0	--	
Turn -Off Delay Time	$T_d(off)$	$V_{DD} = 400V,$ $I_D = 11.0A$ $R_G = 25\Omega$	--	145	--	ns
Turn-on delay time	$T_d(on)$		--	70	--	
Rise time	$T_r$		--	70	--	
Fall time	$T_f$		--	59	--	
Total Gate Charge	$Q_g$	$I_D = 11A,$ $V_{DS} = 520V$ $V_{GS} = 10V$	--	22	---	nC
Gate-to-Source Charge	$Q_{gs}$		--	4	--	
Gate-to-Drain Charge	$Q_{gd}$		--	8	---	
Continuous Diode Forward Current	$I_s$		--	--	9.4	A
Pulsed Diode Forward Current <sup>1</sup>	$I_{SM}$		--	--	33	A
Diode Forward Voltage	$V_{SD}$	$T_J = 25^\circ C, I_s = 5.5A$ $V_{GS} = 0V$	--	0.9	1.2	V
Reverse Recovery Time	trr	$V_{RR} = 400V,$ If=Is diF/dt=100A/ $\mu s$	--	377	--	ns
Reverse Recovery Charge	Qrr		--	3.4	--	$\mu C$
Peak Reverse Recovery Current	$I_{RRM}$		--	17.8	--	A

**●Thermal Characteristics**

PARAMETER	SYMBOL	MAX		UNIT
		TO-252	TO-220F	
Thermal Resistance Junction-case	$R_{thJC}$	1.51	4	$^\circ C/W$
Thermal Resistance Junction-ambient	$R_{thJA}$	62	80	$^\circ C/W$

Notes:

- 1.Repetitive Rating: Pulse width limited by maximum junction temperature.
2.  $I_{AS} = 1.8A, V_{DD} = 50V, R_G = 25\Omega, \text{Starting } T_J = 25^\circ C$
3. Pulse Test : Pulse width  $\leq 300\mu s, \text{Duty cycle } \leq 2\%$

• **Typical Characteristics**  $T_J=25^\circ\text{C}$ , unless otherwise noted

**Figure 1. Output Characteristics**

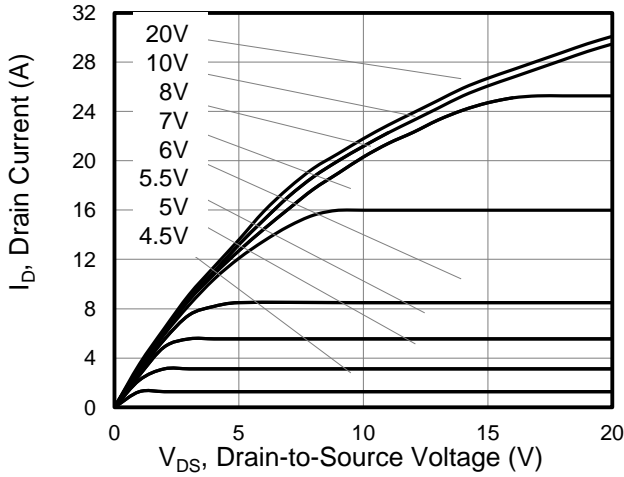

**Figure 2. Transfer Characteristics**

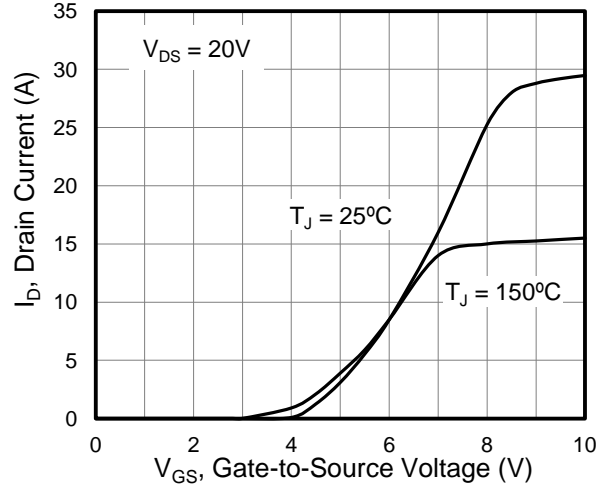

**Figure 3. On-Resistance vs. Drain Current**

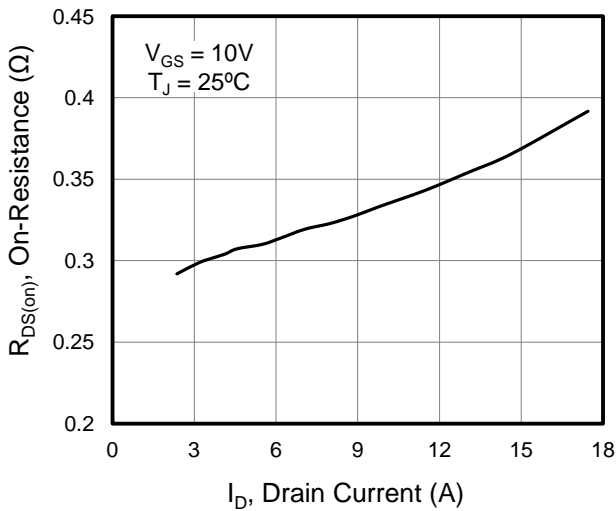

**Figure 4. Capacitance**

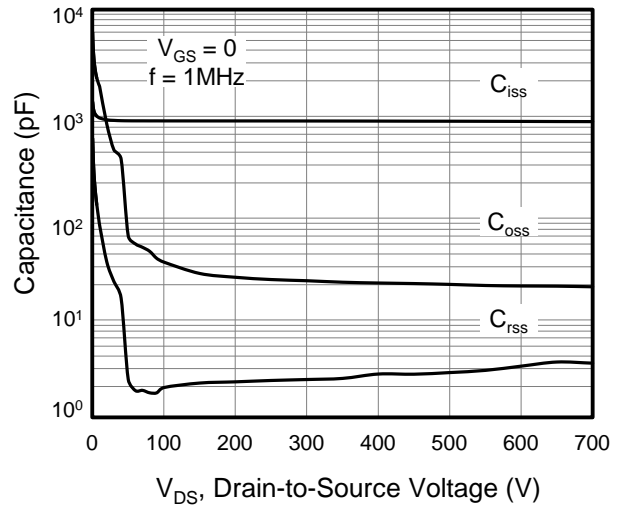

**Figure 5. Gate Charge**

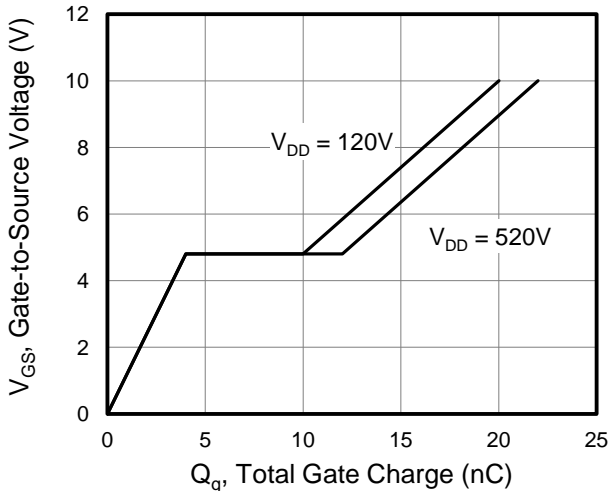

**Figure 6. Body Diode Forward Voltage**

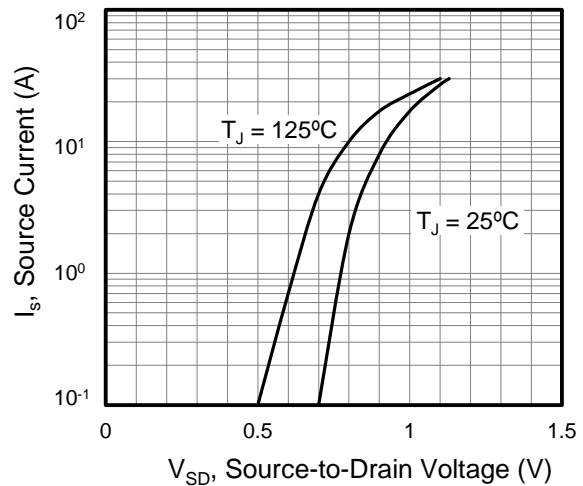

• Typical Characteristics(Cont.)

Figure 7. On-Resistance vs. Junction Temperature

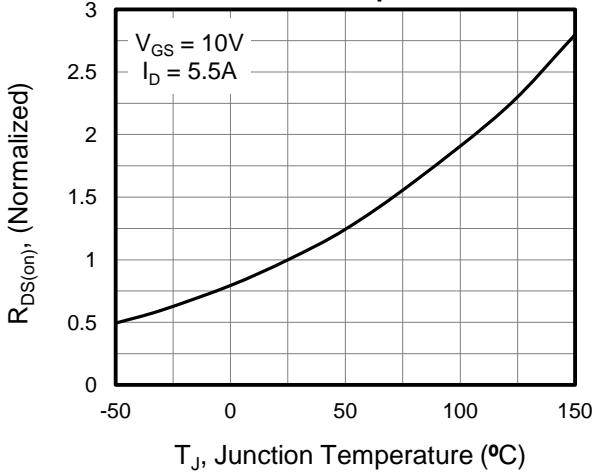

Figure 8. Breakdown voltage vs. Junction Temperature

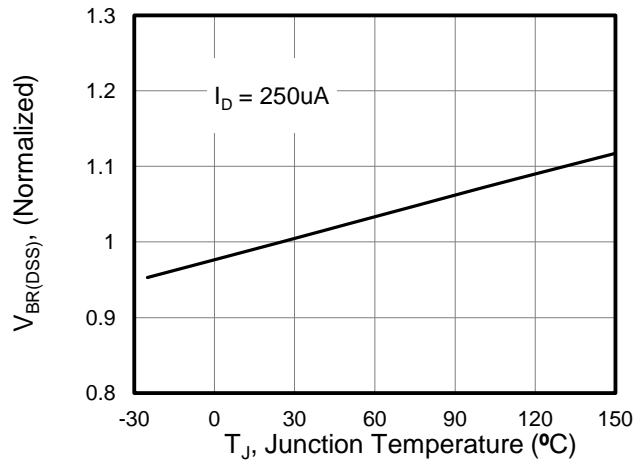

Figure 9. Transient Thermal Impedance

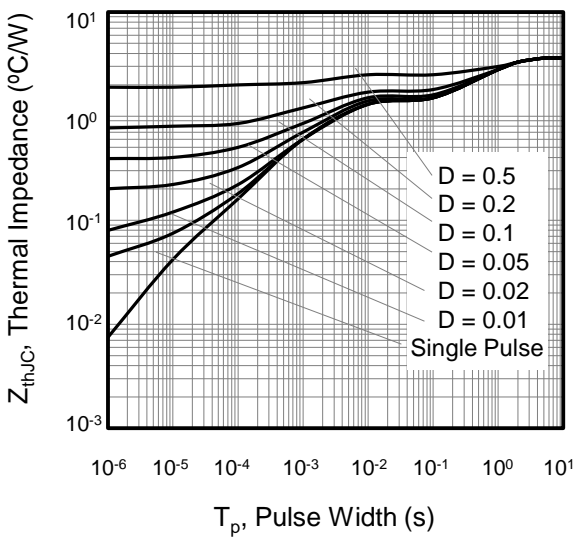
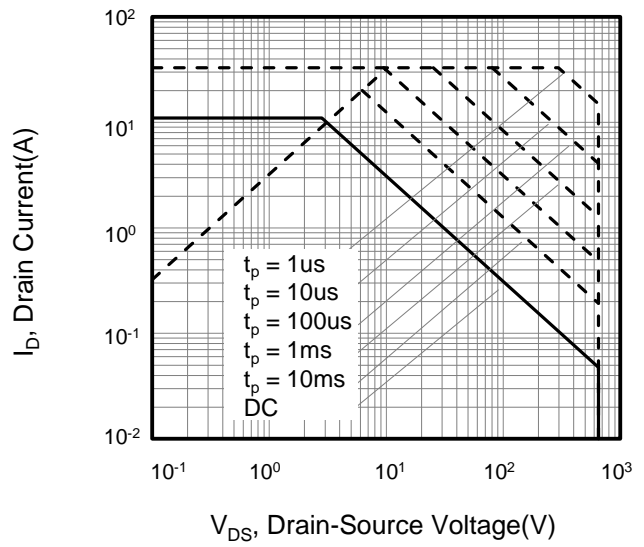

Figure 10. Safe operation area



• Test Circuit and Waveforms

Figure A: Gate Charge Test Circuit and Waveform

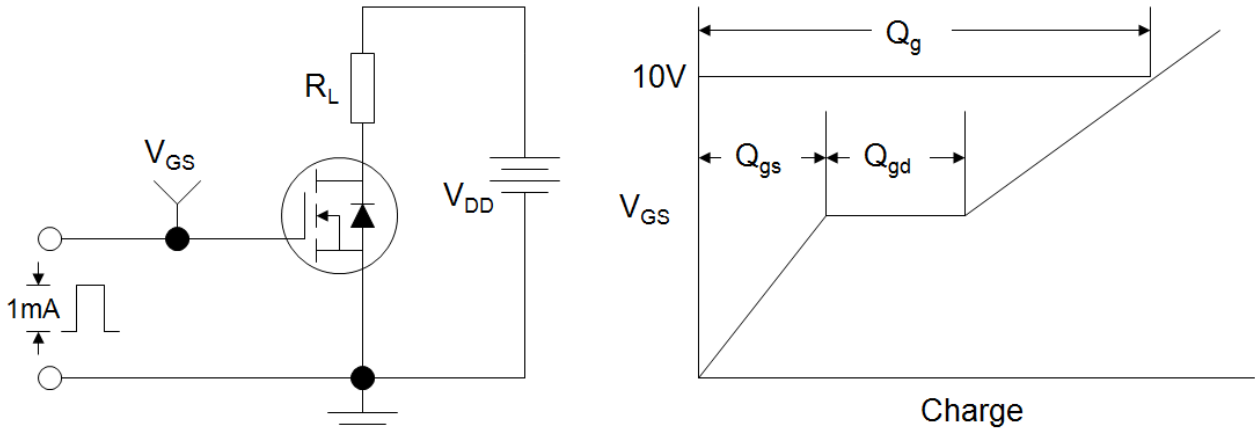

Figure B: Resistive Switching Test Circuit and Waveform

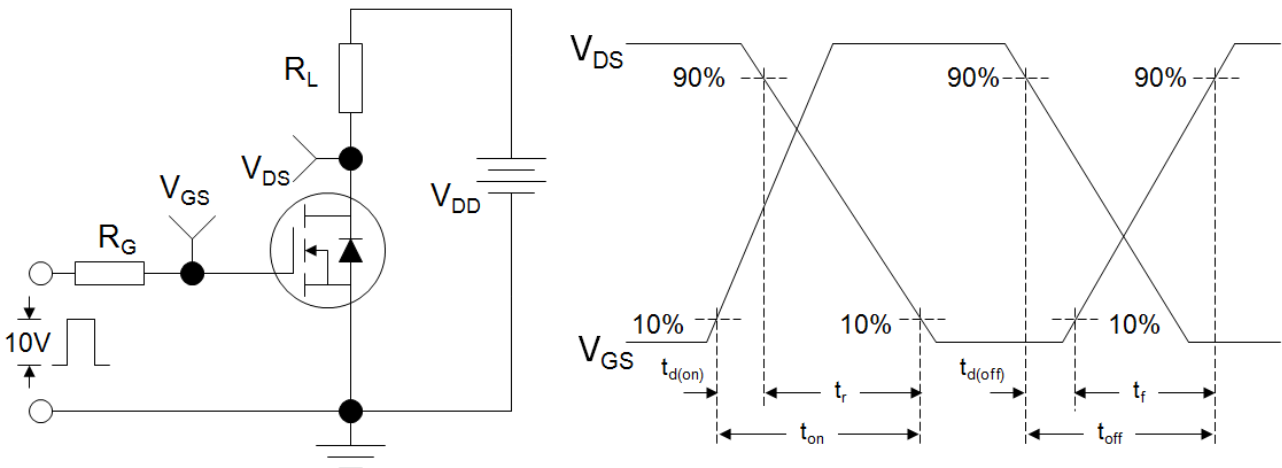
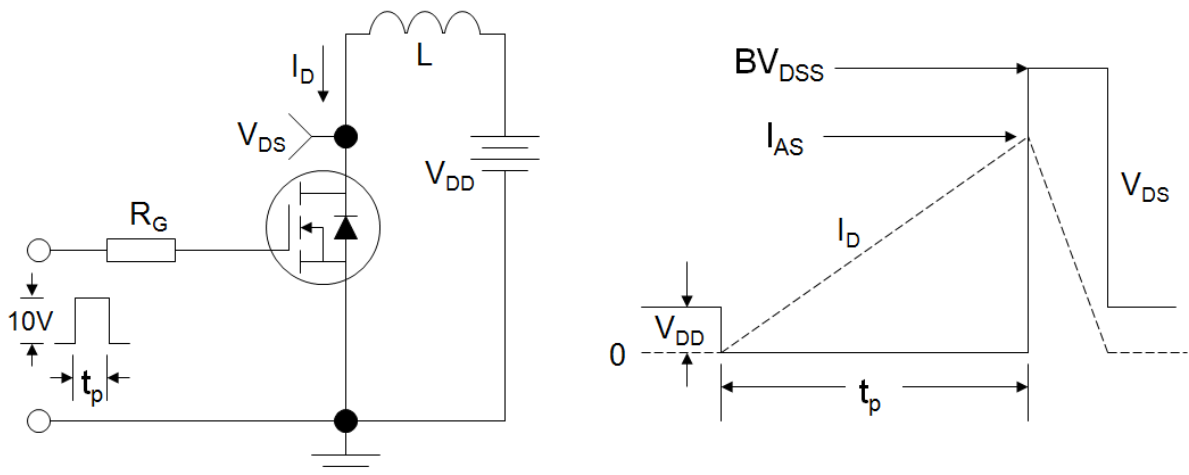

Figure C: Unclamped Inductive Switching Test Circuit and Waveform



●Dimensions (TO-252)

UNIT:mm

SYMBOL	min	max	SYMBOL	min	max
A	2.10	2.50	L2	0.60	1.20
b	0.50	0.90	L3	1.20	1.80
b1	0.70	1.20	B	0.80	1.30
b2	0.40	0.70	C	0.40	0.70
D	6.20	6.80	D1	5.10	5.60
E	5.80	6.40	e1	2.10	2.45
L	3.60	4.60	e2	4.40	4.80
L1	0.80	1.60			

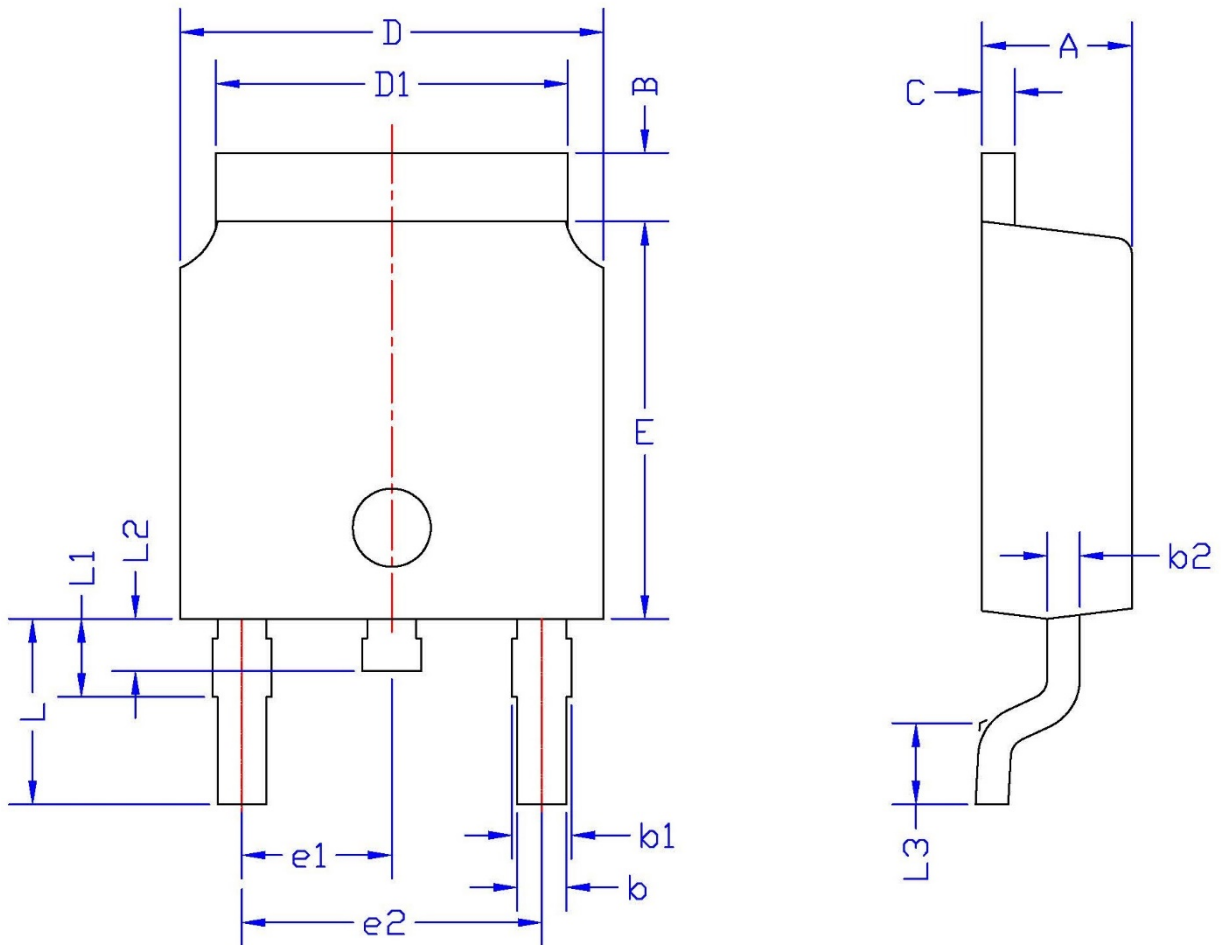

•Dimensions (TO-220F)

UNIT:mm

SYMBOL	min	max	SYMBOL	min	max
A	4.20	4.80	E1	8.30	8.70
A1	2.50	2.90	e	2.40	2.70
A2	2.90	3.30	e1	4.95	5.25
b	0.40	0.80	F	2.50	2.90
b1	1.10	1.50	L	13.00	14.00
c	0.50	0.70	L1	3.00	4.00
D	9.80	10.60	∅P	2.90	3.50
E	14.60	15.60			

